

Further Graphics

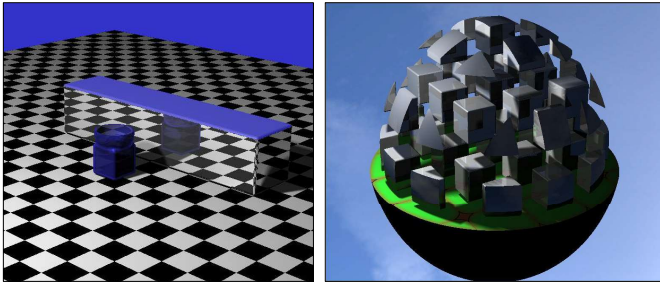

Ray Marching and Signed Distance Fields

Alex Benton, University of Cambridge - alex@bentonian.com
Supported in part by Google UK, Ltd

1

GPU Ray-tracing

Ray tracing 101: "Choose the color of the pixel by firing a ray through and seeing what it hits."

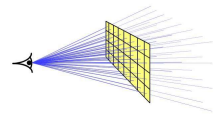

Ray tracing 102: "Let the pixel make up its own mind."

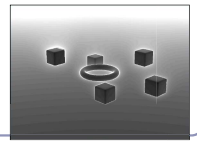
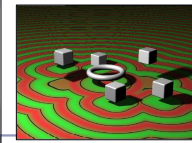
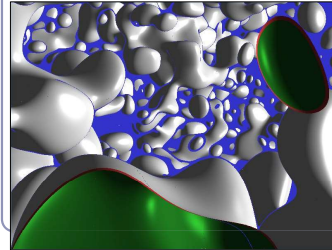

2

GPU Ray-tracing

1. Use a minimal vertex shader (no transforms) - all work happens in the fragment shader
2. Set up OpenGL with minimal geometry, a single quad
3. Bind coordinates to each vertex, let the GPU interpolate coordinates to every pixel
4. Implement raytracing in GLSL:
 - a. For each pixel, compute the ray from the eye through the pixel, using the interpolated coordinates to identify the pixel
 - b. Run the ray tracing algorithm for every ray

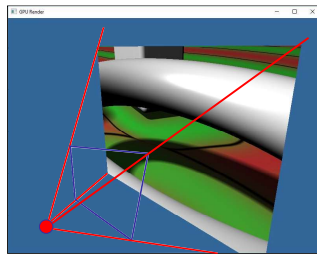

3

GPU Ray-tracing

```
// Window dimensions
uniform vec2 iResolution;

// Camera position
uniform vec3 iRayOrigin;

// Camera facing direction
uniform vec3 iRayDir;

// Camera up direction
uniform vec3 iRayUp;

// Distance to viewing plane
uniform float iPlaneDist;

// 'Texture' coordinate of each
// vertex, interpolated across
// fragments (0,0) -> (1,1)
in vec2 texCoord;
```

```
vec3 getRayDir(
    vec3 camDir,
    vec3 camUp,
    vec2 texCoord) {
    vec3 camSide = normalize(
        cross(camDir, camUp));
    vec2 p = 2.0 * texCoord - 1.0;
    p.x *= iResolution.x
        / iResolution.y;
    return normalize(
        p.x * camSide
        + p.y * camUp
        + iPlaneDist * camDir);
}
```

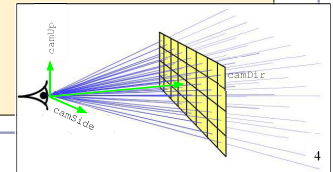

4

GPU Ray-tracing: Sphere

```
Hit traceSphere(vec3 rayorig, vec3 raydir, vec3 pos, float radius) {
    float OdotD = dot(rayorig - pos, raydir);
    float OdotO = dot(rayorig - pos, rayorig - pos);
    float base = OdotD * OdotD - OdotO + radius * radius;

    if (base >= 0) {
        float root = sqrt(base);
        float t1 = -OdotD + root;
        float t2 = -OdotD - root;
        if (t1 >= 0 || t2 >= 0) {
            float t = (t1 < t2 && t1 >= 0) ? t1 : t2;
            vec3 pt = rayorig + raydir * t;
            vec3 normal = normalize(pt - pos);
            return Hit(pt, normal, t);
        }
    }
    return Hit(vec3(0), vec3(0), -1);
}
```

5

An alternative to raytracing: Ray-marching

An alternative to classic ray-tracing is ray-marching, in which we take a series of finite steps along the ray until we strike an object or exceed the number of permitted steps.

- Also sometimes called ray casting
- Scene objects only need to answer, "has this ray hit you? y/n"
- Great solution for data like height fields
- Unfortunately...
 - often involves many steps
 - too large a step size can lead to lost intersections (step over the object)
 - an `if()` test in the heart of a `for()` loop is very hard for the GPU to optimize

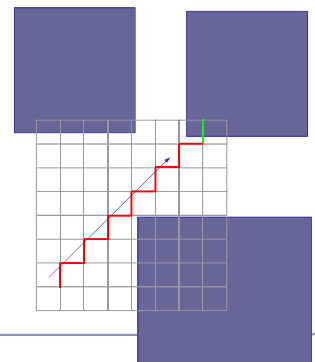

GPU Ray-marching: Signed distance fields

Ray-marching can be dramatically improved, to impressive realtime GPU performance, using *signed distance fields*:

1. Fire ray into scene
2. At each step, measure distance field function: $d(p) = [\text{distance to nearest object in scene}]$
3. Advance ray along ray heading by distance d , because the nearest intersection can be no closer than d

This is also sometimes called 'sphere tracing'. Early paper: <http://graphics.cs.illinois.edu/sites/default/files/rtps.pdf>

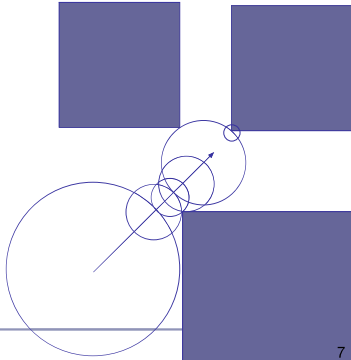

7

Signed distance fields

An *SDF* returns the minimum possible distance from point p to the surface it describes.

The sphere, for instance, is the distance from p to the center of the sphere, minus the radius.

Negative values indicate a sample inside the surface, and still express absolute distance to the surface.

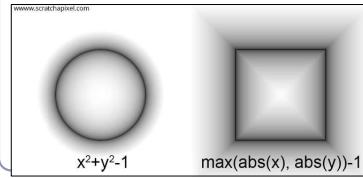

<https://www.scratchapixel.com/lessons/advanced-rendering/rendering-distance-fields>

```
float sphere(vec3 p, float r) {
    return length(p) - r;
}

float cube(vec3 p, vec3 dim) {
    vec3 d = abs(p) - dim;
    return min(max(d.x,
        max(d.y, d.z)), 0.0)
        + length(max(d, 0.0));
}

float cylinder(vec3 p, vec3 dim) {
    return length(p.xz - dim.xy)
        - dim.z;
}

float torus(vec3 p, vec2 t) {
    vec2 q = vec2(
        length(p.xz) - t.x, p.y);
    return length(q) - t.y;
}
```

8

Raymarching signed distance fields

```
vec3 raymarch(vec3 pos, vec3 raydir) {
    int step = 0;
    float d = getSdf(pos);

    while (abs(d) > 0.001 && step < 50) {
        pos = pos + raydir * d;
        d = getSdf(pos); // Return sphere(pos) or any other
        step++;
    }

    return
        (step < 50) ? illuminate(pos, raydir) : background;
}
```

9

Visualizing step count

Final image

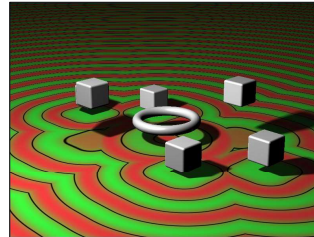

Distance field

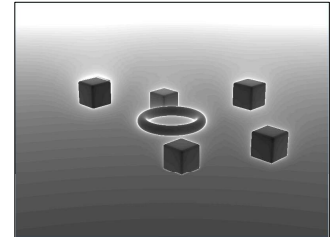

10

Combining SDFs

We combine SDF models by choosing which is closer to the sampled point.

- Take the **union** of two SDFs by taking the $\min()$ of their functions.
- Take the **intersection** of two SDFs by taking the $\max()$ of their functions.
- The $\max()$ of function A and the negative of function B will return the **difference** of A - B.

By combining these binary operations we can create functions which describe very complex primitives.

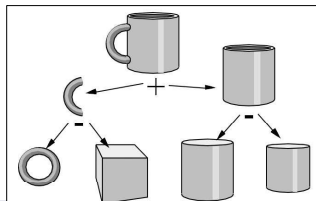
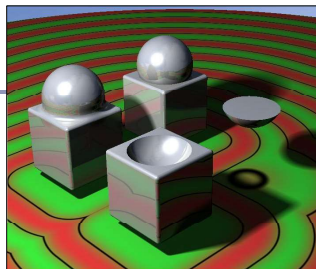

11

Combining SDFs

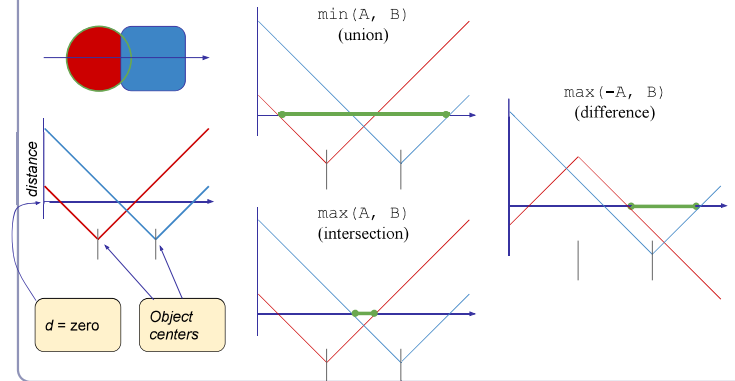

12

Blending SDFs

Taking the `min()`, `max()`, etc of two SDFs yields a sharp discontinuity. *Interpolating* the two SDFs with a smooth polynomial yields a smooth distance curve, blending the models:

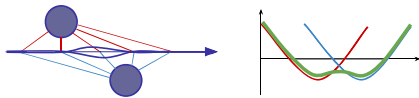

Sample blending function (Quilez)

```
float smin(float a, float b) {
    float k = 0.2;
    float h = clamp(0.5 + 0.5 * (b - a) / k, 0, 1);
    return mix(b, a, h) - k * h * (1 - h);
}
```

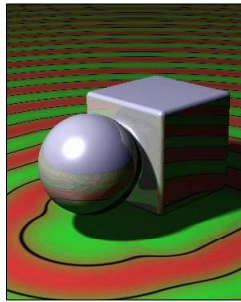

<http://iquilezles.org/www/articles/smin/smin.htm>

Transforming SDF geometry

To rotate, translate or scale an SDF model, apply the inverse transform to the input point within your distance function.

Ex:

```
float sphere(vec3 pt, float radius) {
    return length(pt) - radius;
}

float f(vec3 pt) {
    return sphere(pt - vec3(0, 3, 0));
}
```

This renders a sphere centered at $(0, 3, 0)$.

More prosaically, assemble your local-to-world transform as usual, but apply its inverse to the `pt` within your distance function.

14

Transforming SDF geometry

```
float fScene(vec3 pt) {
    // Scale 2x along X
    mat4 S = mat4(
        vec4(2, 0, 0, 0),
        vec4(0, 1, 0, 0),
        vec4(0, 0, 1, 0),
        vec4(0, 0, 0, 1));

    // Rotation in XY
    float t = sin(time) * PI / 4;
    mat4 R = mat4(
        vec4(cos(t), sin(t), 0, 0),
        vec4(-sin(t), cos(t), 0, 0),
        vec4(0, 0, 1, 0),
        vec4(0, 0, 0, 1));

    // Translate to (3, 3, 3)
    mat4 T = mat4(
        vec4(1, 0, 0, 3),
        vec4(0, 1, 0, 3),
        vec4(0, 0, 1, 3),
        vec4(0, 0, 0, 1));

    pt = (vec4(pt, 1) * inverse(S * R * T)).xyz;
    return sdSphere(pt, 1);
}
```

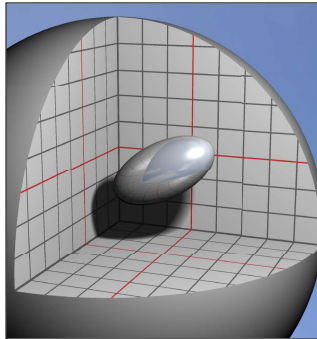

15

Transforming SDF geometry

The previous example modified 'all of space' with the same transform, so its distance functions retain their local linearity.

We can also apply non-uniform spatial distortion, such as by choosing how much we'll modify space as a function of where in space we are.

```
float fScene(vec3 pt) {
    pt.y -= 1;
    float t = (pt.y + 2.5) * sin(time);
    return sdCube(vec3(
        pt.x * cos(t) - pt.z * sin(t),
        pt.y / 2,
        pt.x * sin(t) + pt.z * cos(t)), vec3(1));
}
```

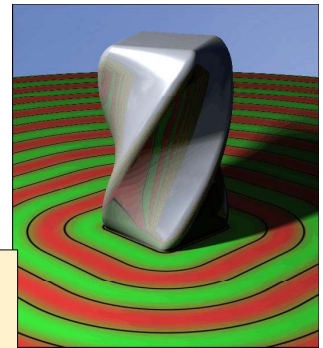

16

Find the normal to an SDF

Finding the normal: local gradient

```
float d = getSdf(pt);
vec3 normal = normalize(vec3(
    getSdf(vec3(pt.x + 0.0001, pt.y, pt.z)) - d,
    getSdf(vec3(pt.x, pt.y + 0.0001, pt.z)) - d,
    getSdf(vec3(pt.x, pt.y, pt.z + 0.0001)) - d));
```

The distance function is locally linear and changes most as the sample moves directly away from the surface. At the surface, the direction of greatest change is therefore equivalent to the normal to the surface. Thus the local gradient (the normal) can be approximated from the distance function.

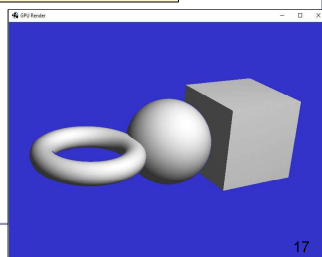

17

SDF shadows

Ray-marched shadows are straightforward: march a ray towards each light source, don't illuminate if the SDF ever drops too close to zero.

Unlike ray-tracing, soft shadows are almost free with SDFs: attenuate illumination by a linear function of the ray marching *near* to another object.

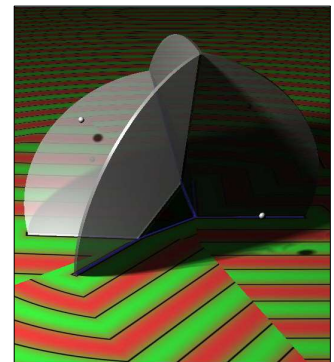
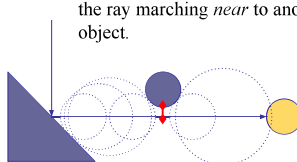

18

Soft SDF shadows

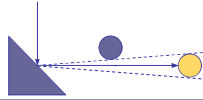

```
float shadow(vec3 pt) {
    vec3 lightDir = normalize(lightPos - pt);
    float kd = 1;
    int step = 0;

    for (float t = 0.1;
         t < length(lightPos - pt)
         && step < renderDepth && kd > 0.001; ) {
        float d = abs(getSDF(pt + t * lightDir));
        if (d < 0.001) {
            kd = 0;
        } else {
            kd = min(kd, 16 * d / t);
        }
        t += d;
        step++;
    }
    return kd;
}
```

By dividing d by t , we attenuate the strength of the shadow as its source is further from the illuminated point.

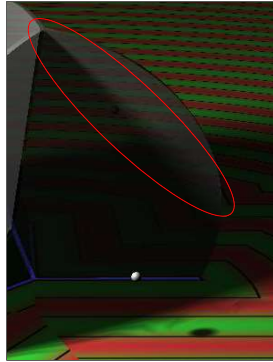

19

Repeating SDF geometry

If we take the modulus of a point's position along one or more axes before computing its signed distance, then we segment space into infinite parallel regions of repeated distance. Space near the origin 'repeats'.

With SDFs we get infinite repetition of geometry for no extra cost.

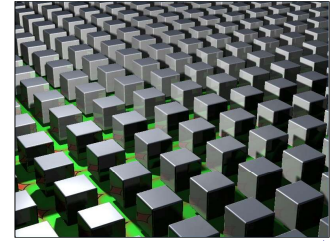

```
float fScene(vec3 pt) {
    vec3 pos;
    pos = vec3(mod(pt.x + 2, 4) - 2, pt.y, mod(pt.z + 2, 4) - 2);
    return sdCube(pos, vec3(1));
}
```

20

Repeating SDF geometry

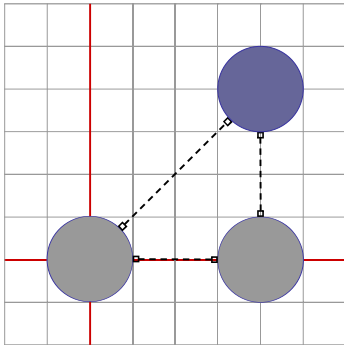

```
float sphere(vec3 pt, float radius) {
    return length(pt) - radius;
}
```

- $\text{sdSphere}(4, 4)$
 $= \sqrt{(4*4+4*4)} - 1$
 $= \sim 4.5$
- $\text{sdSphere}((4 + 2) \% 4 - 2, 4)$
 $= \sqrt{(0*0+4*4)} - 1$
 $= 3$
- $\text{sdSphere}((4 + 2) \% 4 - 2, ((4 + 2) \% 4) - 2)$
 $= \sqrt{(0*0+0*0)} - 1$
 $= -1$ // Inside surface

21

SDF - Live demo

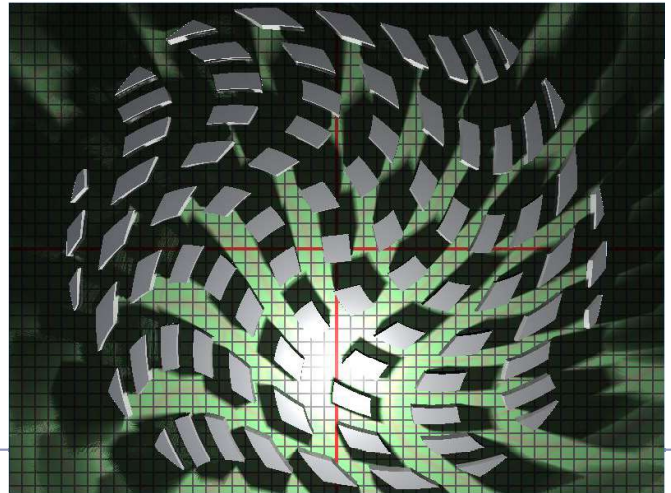

22

Recommended reading

Seminal papers:

- John C. Hart, "Sphere Tracing: A Geometric Method for the Antialiased Ray Tracing of Implicit Surfaces", <http://graphics.cs.illinois.edu/papers/zeno>
- John C. Hart et al., "Ray Tracing Deterministic 3-D Fractals", <http://graphics.cs.illinois.edu/sites/default/files/rtqs.pdf>

Special kudos to Inigo Quilez and his amazing blog:

- <http://iquilezles.org/www/articles/smin/smin.htm>
- <http://iquilezles.org/www/articles/distfunctions/distfunctions.htm>

Other useful sources:

- Johann Komdorfer, "How to Create Content with Signed Distance Functions", <https://www.youtube.com/watch?v=s8nFawOho-s>
- Daniel Wright, "Dynamic Occlusion with Signed Distance Fields", <http://advances.realtimerendering.com/s2015/DynamicOcclusionWithSignedDistanceFields.pdf>
- 9bit Science, "Raymarching Distance Fields", http://9bitscience.blogspot.co.uk/2013/07/raymarching-distance-fields_j4.html

23



"Cornell Box" by Steven Parker, University of Utah
 A library of non-linear renderings of the Cornell Box, generated in a CPU ray-tracer on an Origin 2000. The full image
 contains 248 x 248 pixels with over 1000 primary rays per pixel (3 x 31 pixel samples). Over one
 billion rays were traced for the generation of this image.

Alex Banton, University of Cambridge - alex@bantonian.com
 Supported in part by Google, UK, Ltd.

Barycentric coordinates

```
// Compute barycentric coordinates (u, v, w) for
// point p with respect to triangle (a, b, c)
vec3 barycentric(vec3 p, vec3 a, vec3 b, vec3 c) {
    vec3 v0 = b - a, v1 = c - a, v2 = p - a;
    float d00 = dot(v0, v0);
    float d01 = dot(v0, v1);
    float d11 = dot(v1, v1);
    float d20 = dot(v2, v0);
    float d21 = dot(v2, v1);
    float denom = d00 * d11 - d01 * d01;
    float v = (d11 * d20 - d01 * d21) / denom;
    float w = (d00 * d21 - d01 * d20) / denom;
    float u = 1.0 - v - w;
    return vec3(u, v, w);
}
```

Code credit: Christer Ericson, *Real-Time Collision Detection* (2004)
(adapted to GLSL for this lecture)

31

Hard shadows

To simulate shadows with rays, fire a ray from P towards each light L_i . If the ray hits another object before the light, then discard L_i in the sum.

- This is a boolean removal, so it will give hard-edged shadows.
- Hard-edged shadows suggest a pinpoint light source.

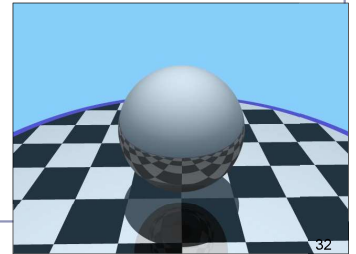

32

Softer shadows

Shadows in nature are not sharp because light sources are not infinitely small.

- Also because light scatters, etc.

For lights with volume, fire many rays, covering the cross-section of your illuminated space.

Illumination is scaled by (the total number of rays that aren't blocked) divided by (the total number of rays fired).

- This is an example of *Monte-Carlo integration*: a coarse simulation of an integral over a space by randomly sampling it with many rays.
- The more rays fired, the smoother the result.

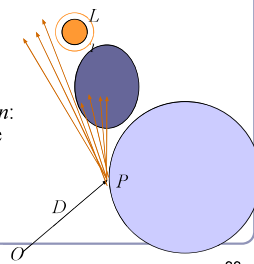

33

Softer shadows

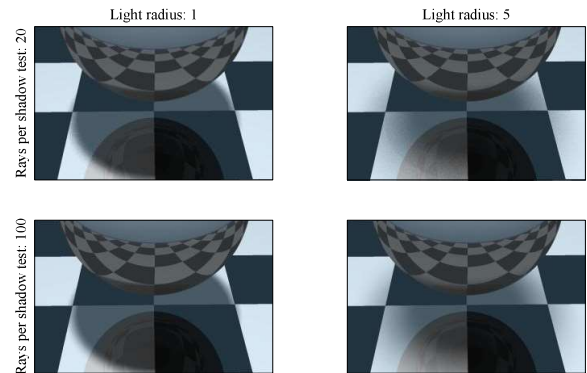

All images anti-aliased with 4x supersampling.
Distance to light in all images: 20 units

Spotlights

To create a spotlight shining along axis S , you can multiply the (diffuse+specular) term by $(\max(L \cdot S, 0))^m$.

- Raising m will tighten the spotlight, but leave the edges soft.
- If you'd prefer a hard-edged spotlight of uniform internal intensity, you can use a conditional, e.g. $((L \cdot S > \cos(15^\circ)) ? 1 : 0)$.

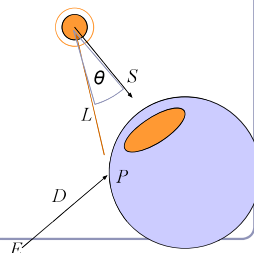

35

Transparency and Refraction

To add transparency, generate and trace a new *transparency ray* with $E_T = P$, $D_T = D$.

For realism, D_T should deviate (slightly) from D . The *angle of incidence* of a ray of light where it strikes a surface is the acute angle between the ray and the surface normal.

The *refractive index* of a material is a measure of how much the speed of light¹ is reduced inside the material.

- The refractive index of air is about 1.003.
- The refractive index of water is about 1.33.

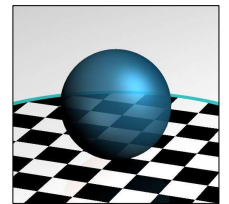
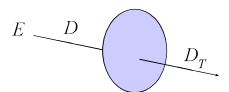

¹ Or sound waves or other waves

Refraction

Snell's Law:

$$\frac{\sin \theta_1}{\sin \theta_2} = \frac{n_2}{n_1} = \frac{v_1}{v_2}$$

“The ratio of the sines of the *angles of incidence* of a ray of light at the interface between two materials is equal to the inverse ratio of the *refractive indices* of the materials is equal to the ratio of the speeds of light in the materials.”

Historical note: this formula has been attributed to Willebrord Snell (1591-1626) and René Descartes (1596-1650) but first discovery goes to Ibn Sahl (940-1000) of Baghdad.

37

Refraction for rays

$$\theta_1 = \cos^{-1}(N \bullet D)$$

$$\frac{\sin \theta_1}{\sin \theta_2} = \frac{n_2}{n_1} \rightarrow \theta_2 = \sin^{-1}\left(\frac{n_1}{n_2} \sin \theta_1\right)$$

Using Snell's Law and the angle of incidence of the incoming ray, we can calculate the angle from the negative normal to the outbound ray.

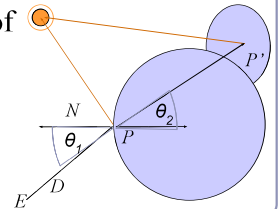

38

Refraction in ray tracing

What if the arcsin parameter is > 1 ?

- Remember, arcsin is defined in $[-1, 1]$.
- We call this the *angle of total internal reflection*: light is trapped completely inside the surface.

$$\theta_2 = \sin^{-1}\left(\frac{n_1}{n_2} \sin \theta_1\right)$$

Total internal reflection

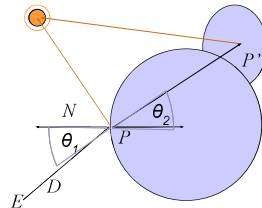

39

Fresnel term

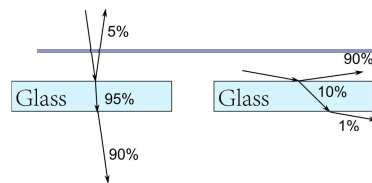

- Light is more likely to be reflected rather than transmitted near grazing angles
- This effect is modelled by *Fresnel equation*, which gives the probability that a photon is reflected rather than transmitted (or absorbed)

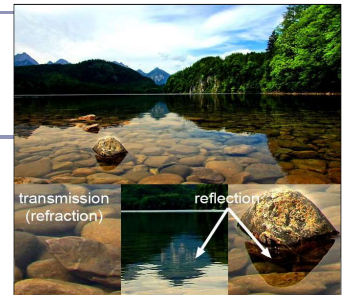

Example from: <https://www.scratchapixel.com/lessons/3d-basic-rendering/introduction-to-shading/reflection-refraction-fresnel>

40

Aliasing

aliasing

/'eɪliəzɪŋ/

noun: **aliasing**

1. PHYSICS / TELECOMMUNICATIONS

the misidentification of a signal frequency, introducing distortion or error.

"high-frequency sounds are prone to aliasing"

2. COMPUTING

the distortion of a reproduced image so that curved or inclined lines appear inappropriately jagged, caused by the mapping of a number of points to the same pixel.

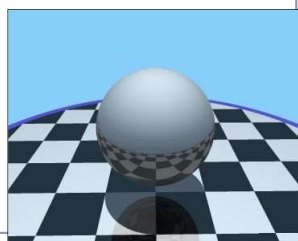
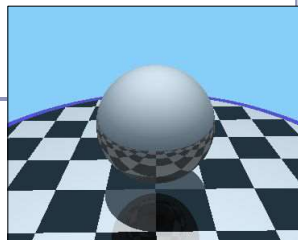

41

Aliasing

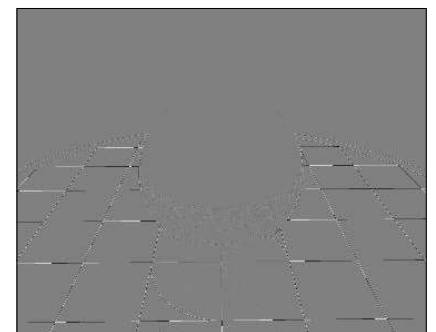
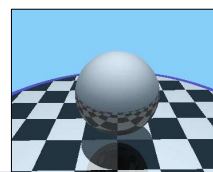
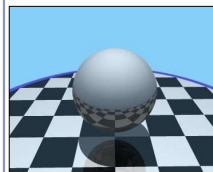

42

Anti-aliasing

Fundamentally, the problem with aliasing is that we're sampling an infinitely continuous function (the color of the scene) with a finite, discrete function (the pixels of the image).

One solution to this is *super-sampling*. If we fire multiple rays through each pixel, we can average the colors computed for every ray together to a single blended color.

To avoid heavy computational load And also avoid sub-super-sampling artifacts, consider using *jittered super-sampling*.

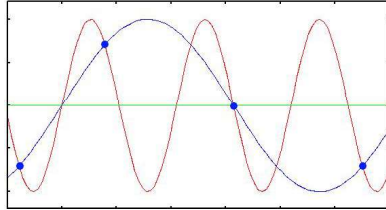

Image source: www.svg.it

43

Applications of super-sampling

- Anti-aliasing
- Soft shadows
- Depth-of-field camera effects (fixed focal depth, finite aperture)

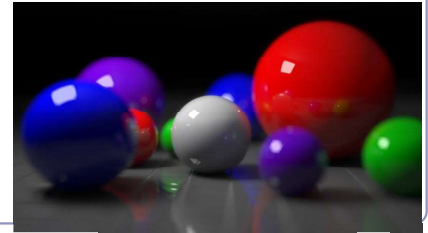
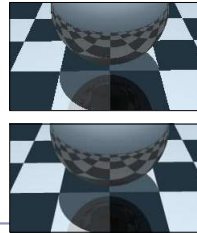
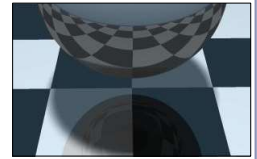

Image credit: http://en.wikipedia.org/wiki/Ray_tracing_graphics

44

Speed things up! Bounding volumes

A common optimization method for ray-based rendering is the use of *bounding volumes*.

Nested bounding volumes allow the rapid culling of large portions of geometry

- Test against the bounding volume of the top of the scene graph and then work down.

Great for...

- Collision detection between scene elements
- Culling before rendering
- Accelerating ray-tracing, -marching

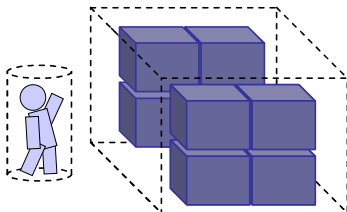

45

Types of bounding volumes

The goal is to accelerate volumetric tests, such as "does the ray hit the cow?" → *speed trumps precision*

- choose fast hit testing over accuracy
- 'bboxes' don't have to be tight

Axis-aligned bounding boxes

- max and min of x/y/z.

Bounding spheres

- max of radius from some rough center

Bounding cylinders

- common in early FPS games

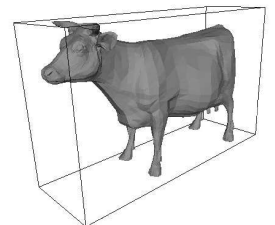

46

Bounding volumes in hierarchy

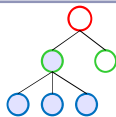

Hierarchies of bounding volumes allow early discarding of rays that won't hit large parts of the scene.

- Pro: Rays can skip subsections of the hierarchy
- Con: Without spatial coherence ordering the objects in a volume you hit, you'll still have to hit-test every object

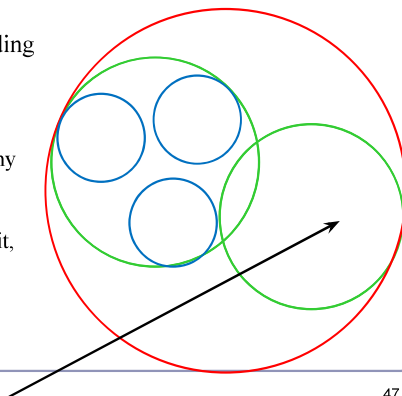

47

Subdivision of space

Split space into cells and list in each cell every object in the scene that overlaps that cell.

- Pro: The ray can skip empty cells
- Con: Depending on cell size, objects may overlap many filled cells or you may waste memory on many empty cells
- Popular for voxelized games (ex: *Minecraft*)

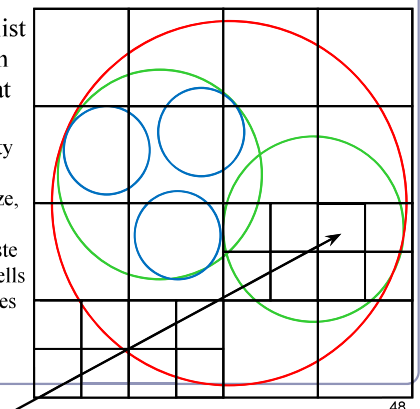

48

Popular acceleration structures: BSP Trees

The *BSP tree* **pre**-partitions the scene into objects in front of, on, and behind a tree of planes.

- This gives an ordering in which to test scene objects against your ray
- When you fire a ray into the scene, you test all near-side objects before testing far-side objects.

Challenges:

- requires slow pre-processing step
- strongly favors static scenes
- choice of planes is hard to optimize

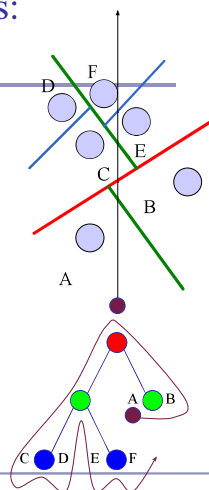

49

Popular acceleration structures: *kd-trees*

The *kd-tree* is a simplification of the BSP Tree data structure

- Space is recursively subdivided by axis-aligned planes and points on either side of each plane are separated in the tree.
- The *kd-tree* has $O(n \log n)$ insertion time (but this is very optimizable by domain knowledge) and $O(n^{2/3})$ search time.
- *kd-trees* don't suffer from the mathematical slowdowns of BSPs because their planes are always axis-aligned.

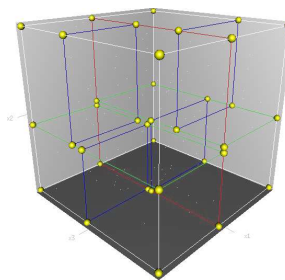

Image from Wikipedia, bless their hearts.

50

Popular acceleration structures: *Bounding Interval Hierarchies*

The *Bounding Interval Hierarchy* subdivides space around the volumes of objects and shrinks each volume to remove unused space.

- Think of this as a “best-fit” *kd-tree*
- Can be built dynamically as each ray is fired into the scene

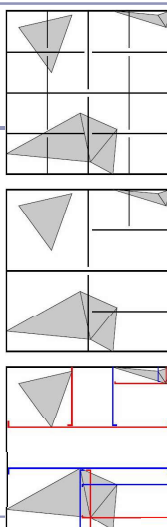

Image from Wächter and Keller's paper, *Instant Ray Tracing: The Bounding Interval Hierarchy*, Eurographics (2006)

51

References

Intersection testing

<http://www.realtimerendering.com/intersections.html>

<http://tog.acm.org/editors/erich/ptinpoly>

<http://mathworld.wolfram.com/BarcentricCoordinates.html>

Ray tracing

Peter Shirley, Steve Marschner. *Fundamentals of Computer Graphics*. Taylor & Francis, 21 Jul 2009

Hughes, Van Dam et al. *Computer Graphics: Principles and Practice*. Addison Wesley, 3rd edition (10 July 2013)

52

Further Graphics

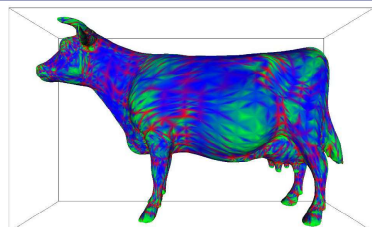

A Brief Introduction to Computational Geometry

Terminology

- We'll be focusing on *discrete* (as opposed to continuous) representation of geometry; i.e., polygon meshes
 - Many rendering systems limit themselves to triangle meshes
 - Many require that the mesh be *manifold*
- In a *closed manifold* polygon mesh:
 - Exactly two triangles meet at each edge
 - The faces meeting at each vertex belong to a single, connected loop of faces
- In a *manifold with boundary*:
 - At most two triangles meet at each edge
 - The faces meeting at each vertex belong to a single, connected strip of faces

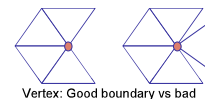
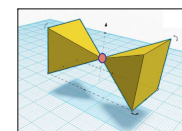
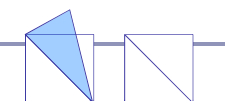

Terminology

- We say that a surface is *oriented* if:
 - the vertices of every face are stored in a fixed order
 - if vertices i, j appear in both faces $f1$ and $f2$, then the vertices appear in order i, j in one and j, i in the other
- We say that a surface is *embedded* if, informally, “nothing pokes through”:
 - No vertex, edge or face shares any point in space with any other vertex, edge or face except where dictated by the data structure of the polygon mesh
- A closed, embedded surface must separate 3-space into two parts: a bounded *interior* and an unbounded *exterior*.

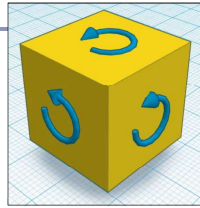

A cube with “anti-clockwise” oriented faces

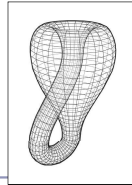

Klein bottle: not an embedded surface. Also, terrible for holding drinks.

This slide draws much inspiration from Hughes and Van Dam’s *Computer Graphics: Principles and Practice*, pp. 637-642

Normal at a vertex

Expressed as a limit,

The *normal of surface S at point P* is the limit of the cross-product between two (non-collinear) vectors from P to the set of points in S at a distance r from P as r goes to zero. [Excluding orientation.]

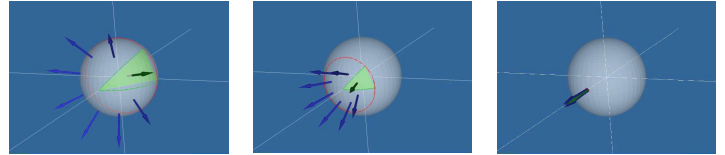

56

Normal at a vertex

Using the limit definition, is the ‘normal’ to a discrete surface necessarily a vector?

- The normal to the surface at any point on a face is a constant vector.
- The ‘normal’ to the surface at any edge is an arc swept out on a unit sphere between the two normals of the two faces.
- The ‘normal’ to the surface at a vertex is a space swept out on the unit sphere between the normals of all of the adjacent faces.

57

Finding the normal at a vertex

Take the weighted average of the normals of surrounding polygons, weighted by each polygon’s *face angle* at the vertex. *Face angle*: the angle α formed at the vertex v by the vectors to the next and previous vertices in the face F

$$\alpha(F, v_i) = \cos^{-1} \left(\frac{v_{i+1} - v_i}{|v_{i+1} - v_i|} \cdot \frac{v_{i-1} - v_i}{|v_{i-1} - v_i|} \right)$$

$$N(v) = \frac{\sum_F \alpha(F, v) N_F}{|\sum_F \alpha(F, v)|}$$

Note: In this equation, *arccos* implies a convex polygon. Why?

58

Gaussian curvature on smooth surfaces

Informally speaking, the *curvature* of a surface expresses “how flat the surface isn’t”.

- One can measure the directions in which the surface is curving *most*; these are the directions of *principal curvature*, k_1 and k_2 .
- The product of k_1 and k_2 is the scalar *Gaussian curvature*.

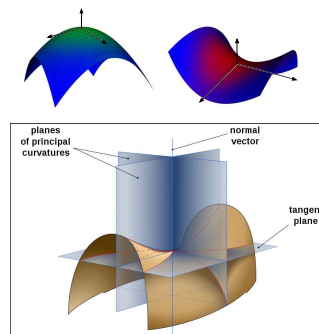

Image by Eric Gaba, from Wikipedia

59

Gaussian curvature on smooth surfaces

Formally, the *Gaussian curvature of a region* on a surface is the ratio between the **area of the surface of the unit sphere swept out by the normals of that region** and the **area of the region itself**.

The Gaussian curvature of a point is the limit of this ratio as the region tends to zero area.

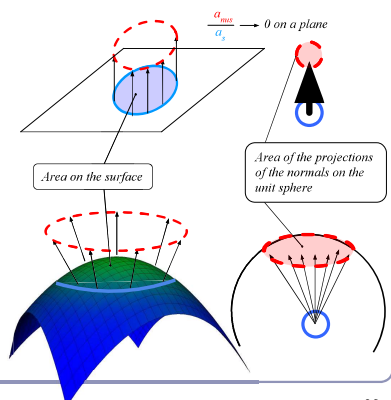

$\frac{a_{ms}}{a_s} \rightarrow r^2$ on a sphere of radius r (please pretend that this is a sphere)

60

Gaussian curvature on discrete surfaces

On a discrete surface, normals do not vary smoothly: the normal to a face is constant on the face, and at edges and vertices the normal is—strictly speaking—undefined.

- Normals change instantaneously (as one's point of view travels across an edge from one face to another) or not at all (as one's point of view travels within a face.)

The Gaussian curvature of the surface of any polyhedral mesh is **zero** everywhere except at the vertices, where it is **infinite**.

61

Angle deficit – a better solution for measuring discrete curvature

The *angle deficit* $AD(v)$ of a vertex v is defined to be two π minus the sum of the face angles of the adjacent faces.

$$AD(v) = 2\pi - \sum_F \alpha(F, v)$$

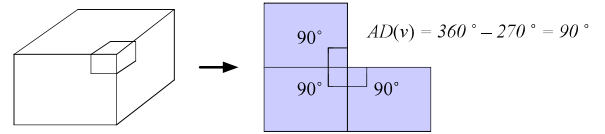

62

Angle deficit

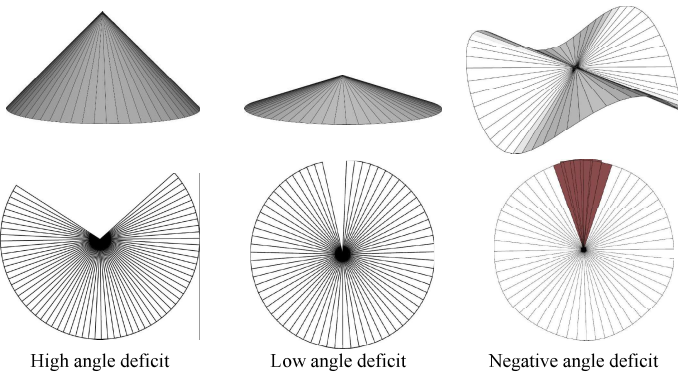

63

Angle deficit

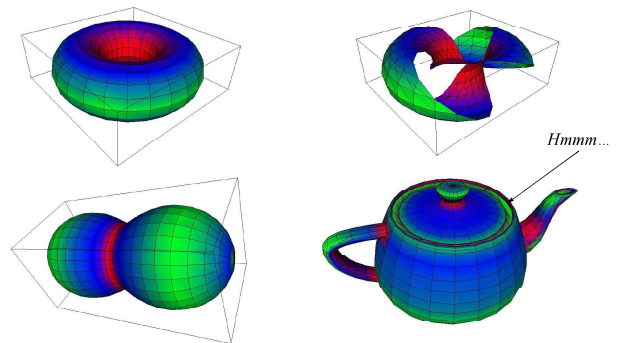

64

Genus, Poincaré and the Euler Characteristic

- Formally, the *genus* g of a closed surface is

...“a topologically invariant property of a surface defined as the largest number of nonintersecting simple closed curves that can be drawn on the surface without separating it.”

--mathworld.com

- Informally, it's the number of coffee cup handles in the surface.

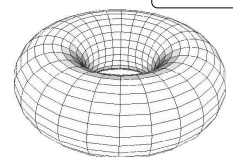
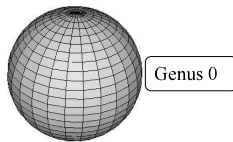

65

Genus, Poincaré and the Euler Characteristic

Given a polyhedral surface S without border where:

- V = the number of vertices of S ,
- E = the number of edges between those vertices,
- F = the number of faces between those edges,
- χ is the *Euler Characteristic* of the surface,

the Poincaré Formula states that:

$$V - E + F = 2 - 2g = \chi$$

66

Genus, Poincaré and the Euler Characteristic

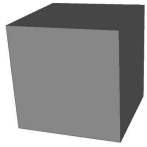

$$\begin{aligned}
 g &= 0 \\
 E &= 12 \\
 F &= 6 \\
 V &= 8 \\
 \underline{V-E+F} &= \underline{2-2g} = 2
 \end{aligned}$$

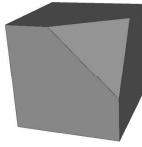

$$\begin{aligned}
 g &= 0 \\
 E &= 15 \\
 F &= 7 \\
 V &= 10 \\
 \underline{V-E+F} &= \underline{2-2g} = 2
 \end{aligned}$$

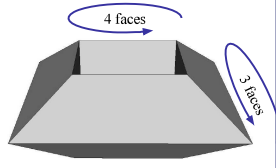

$$\begin{aligned}
 g &= 1 \\
 E &= 24 \\
 F &= 12 \\
 V &= 12 \\
 \underline{V-E+F} &= \underline{2-2g} = 0
 \end{aligned}$$

67

The Euler Characteristic and angle deficit

Descartes' *Theorem of Total Angle Deficit* states that on a surface S with Euler characteristic χ , the sum of the angle deficits of the vertices is $2\pi\chi$:

$$\sum_S AD(v) = 2\pi\chi$$

Cube:

- $\chi = 2 - 2g = 2$
- $AD(v) = \pi/2$
- $8(\pi/2) = 4\pi = 2\pi\chi$

Tetrahedron:

- $\chi = 2 - 2g = 2$
- $AD(v) = \pi$
- $4(\pi) = 4\pi = 2\pi\chi$

68

The Jordan curve theorem

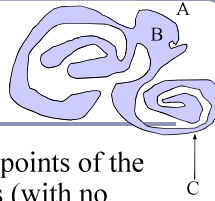

“Any simple closed curve C divides the points of the plane not on C into two distinct domains (with no points in common) of which C is the common boundary.”

- First stated (but proved incorrectly) by Camille Jordan (1838 -1922) in his *Cours d'Analyse*.

Sketch of proof: (For full proof see Courant & Robbins, 1941.)

- Show that any point in A can be joined to any other point in A by a path which does not cross C , and likewise for B .
- Show that any path connecting a point in A to a point in B must cross C .

69

The Jordan curve theorem on a sphere

Note that the Jordan curve theorem can be extended to a curve on a sphere, or anything which is topologically equivalent to a sphere.

“Any simple closed curve on a sphere separates the surface of the sphere into two distinct regions.”

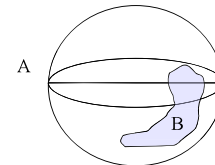

70

Voronoi diagrams

The *Voronoi diagram*⁽²⁾ of a set of points P_i divides space into ‘cells’, where each cell C_i contains the points in space closer to P_i than any other P_j . The *Delaunay triangulation* is the dual of the Voronoi diagram: a graph in which an edge connects every P_i which share a common edge in the Voronoi diagram.

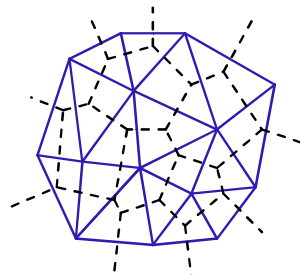

A Voronoi diagram (dotted lines) and its dual Delaunay triangulation (solid).

⁽²⁾ AKA “Voronoi tessellation”; “Dirichlet domain”; “Thiessen polygons”; “pleistohedra”; “fundamental areas”; “domain of action”...

71

Voronoi diagrams

Given a set $S = \{p_1, p_2, \dots, p_n\}$, the formal definition of a Voronoi cell $C(S, p_i)$ is $C(S, p_i) = \{p \in \mathbb{R}^d \mid |p-p_i| < |p-p_j|, i \neq j\}$. The p_i are called the *generating points* of the diagram.

Where three or more boundary edges meet is a *Voronoi point*. Each Voronoi point is at the center of a circle (or sphere, or hypersphere...) which passes through the associated generating points and which is guaranteed to be empty of all other generating points.

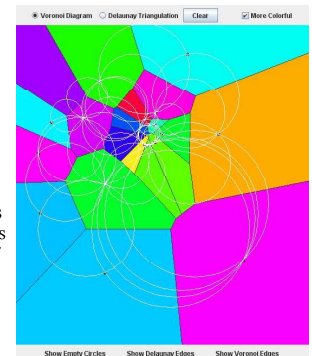

Delaunay triangulation applet by Paul Chew ©1997–2007 <http://www.cs.cornell.edu/home/chew/Delaunay.html>

72

Delaunay triangulations and *equi-angularity*

The *equiangularity* of any triangulation of a set of points S is a sorted list of the angles $(\alpha_1, \dots, \alpha_{3t})$ of the triangles.

- A triangulation is said to be *equiangular* if it possesses lexicographically largest equiangularity amongst all possible triangulations of S .
- The Delaunay triangulation is equiangular.

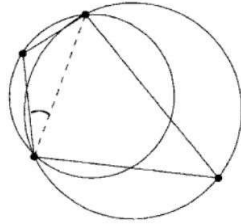

Image from *Handbook of Computational Geometry* (2000) Jörg-Rüdiger Sack and Jorge Urrutia, p. 227

73

Delaunay triangulations and *empty circles*

Voronoi triangulations have the *empty circle* property: in any Voronoi triangulation of S , no point of S will lie inside the circle circumscribing any three points sharing a triangle in the Voronoi diagram.

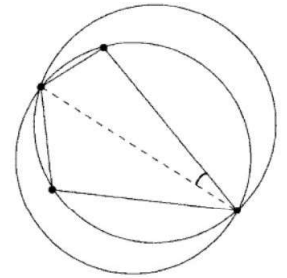

Image from *Handbook of Computational Geometry* (2000) Jörg-Rüdiger Sack and Jorge Urrutia, p. 227

74

Delaunay triangulations and convex hulls

The border of the Delaunay triangulation of a set of points is always convex.

- This is true in 2D, 3D, 4D...

The Delaunay triangulation of a set of points in R^n is the planar projection of a convex hull in R^{n+1} .

- Ex: from 2D $(P_i = \{x, y\}_i)$, loft the points upwards, onto a parabola in 3D $(P'_i = \{x, y, x^2 + y^2\}_i)$. The resulting polyhedral mesh will still be convex in 3D.

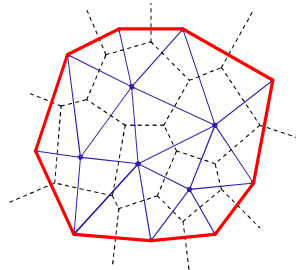

75

Voronoi diagrams and the *medial axis*

The *medial axis* of a surface is the set of all points within the surface equidistant to the two or more nearest points on the surface.

- This can be used to extract a skeleton of the surface, for (for example) path-planning solutions, surface deformation, and animation.

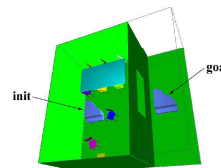

[A Voronoi-Based Hybrid Motion Planner for Rigid Bodies](#)
M Foskey, M Garber, M Lin, DManocha

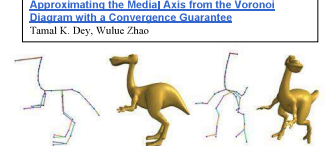

[Shape Deformation using a Skeleton to Drive Sineflex Transformations](#)
IEEE Transactions on Visualization and Computer Graphics, Vol. 14, No. 3, May/June 2008, Page 693-706
Hao-Rong Yan, Shao-Kun Hu, Ralph R. Martin, and Yong-Jiang Yang

76

Fortune's algorithm

1. The algorithm maintains a sweep line and a "beach line", a set of parabolas advancing left-to-right from each point. The beach line is the union of these parabolas.
 - a. The intersection of each pair of parabolas is an edge of the voronoi diagram
 - b. All data to the left of the beach line is "known"; nothing to the right can change it
 - c. The beach line is stored in a binary tree
2. Maintain a queue of two classes of event: the addition of, or removal of, a parabola
3. There are $O(n)$ such events, so Fortune's algorithm is $O(n \log n)$

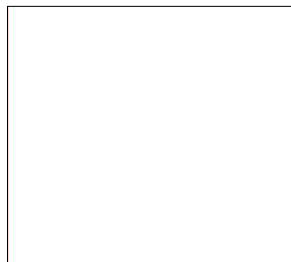

77

GPU-accelerated Voronoi Diagrams

Brute force:

- For each pixel to be rendered on the GPU, search all points for the nearest point

Elegant (and 2D only):

- Render each point as a discrete 3D cone in isometric projection, let z-buffering sort it out

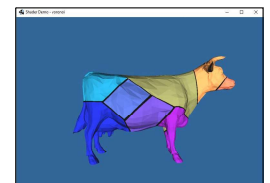
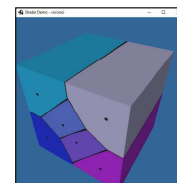
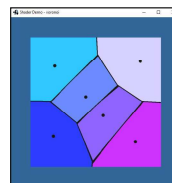

78

References

Gaussian Curvature:

http://en.wikipedia.org/wiki/Gaussian_curvature
<http://mathworld.wolfram.com/GaussianCurvature.html>

The Poincaré Formula:

<http://mathworld.wolfram.com/PoincareFormula.html>

Jordan curves:

R. Courant, H. Robbins, *What is Mathematics?*, Oxford University Press, 1941
<http://cgm.cs.mcgill.ca/~godfried/teaching/cg-projects/97/Octavian/compgeom.html>

Voronoi diagrams:

M. de Berg, O. Cheong, M. van Kreveld, M. Overmars, "*Computational Geometry: Algorithms and Applications*", Springer-Verlag,
<http://www.cs.uu.nl/geobook/>
<http://www.ics.uci.edu/~eppstein/junkyard/nn.html>
<http://www.iquilezles.org/www/articles/voronoilines/voronoilines.htm>

79

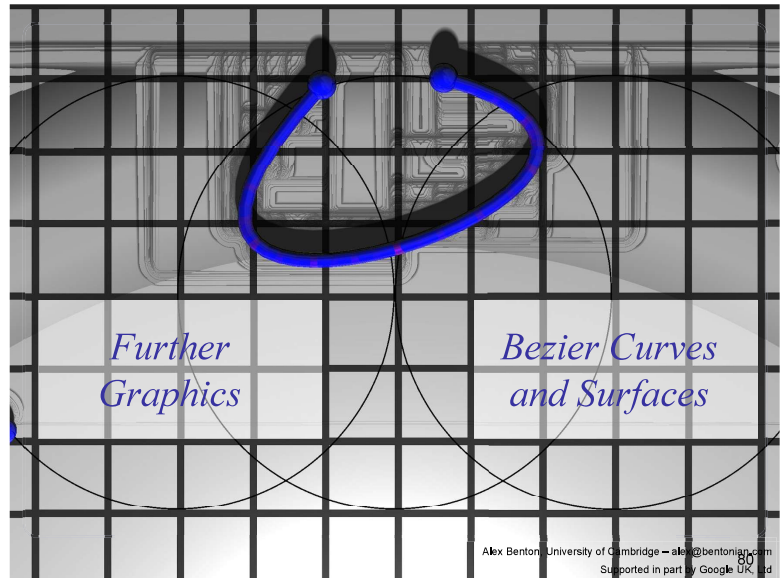

CAD, CAM, and a new motivation: shiny things

Expensive products are sleek and smooth.

→ Expensive products are C2 continuous.



Shiny, but reflections are warped

Shiny, and reflections are perfect

81

The drive for smooth CAD/CAM

- *Continuity* (smooth curves) can be essential to the perception of *quality*.
- The automotive industry wanted to design cars which were aerodynamic, but also visibly of high quality.
- Bezier (Renault) and de Casteljaou (Citroen) invented Bezier curves in the 1960s. de Boor (GM) generalized them to B-splines.

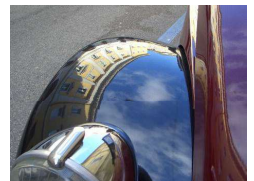

82

History

The term *spline* comes from the shipbuilding industry: long, thin strips of wood or metal would be bent and held in place by heavy 'ducks', lead weights which acted as control points of the curve.

Wooden splines can be described by C_n -continuous Hermite polynomials which interpolate $n+1$ control points.

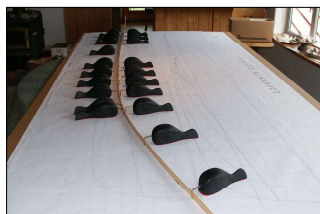

Top: Fig 3, P.7, Bray and Spectre, *Planing and Fastening*, Wooden Boat Pub (1996)
 Bottom: http://www.oranos.com/boatsofwood/lofting%20ducks/lofting_ducks.htm

83

Beziers cubic

- A *Bezier cubic* is a function $P(t)$ defined by four control points:

$$P(t) = (1-t)^3P_0 + 3t(1-t)^2P_1 + 3t^2(1-t)P_2 + t^3P_3$$

- P_0 and P_3 are the endpoints of the curve
- P_1 and P_2 define the other two corners of the bounding polygon.
- The curve fits entirely within the convex hull of $P_0 \dots P_3$.

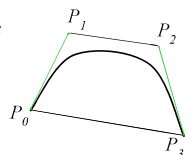

84

Beziers

Cubics are just one example of Bezier splines:

- **Linear:** $P(t) = (1-t)P_0 + tP_1$
- **Quadratic:** $P(t) = (1-t)^2P_0 + 2t(1-t)P_1 + t^2P_2$
- **Cubic:** $P(t) = (1-t)^3P_0 + 3t(1-t)^2P_1 + 3t^2(1-t)P_2 + t^3P_3$

...

General:

$$P(t) = \sum_{i=0}^n \binom{n}{i} (1-t)^{n-i} t^i P_i, \quad 0 \leq t \leq 1$$

"n choose i" = $n! / i!(n-i)!$

85

Beziers

- You can describe Beziers as *nested linear interpolations*:
 - The linear Bezier is a linear interpolation between two points:
 $P(t) = (1-t)(P_0) + t(P_1)$
 - The quadratic Bezier is a linear interpolation between two lines:
 $P(t) = (1-t)((1-t)P_0 + tP_1) + t((1-t)P_1 + tP_2)$
 - The cubic is a linear interpolation between linear interpolations between linear interpolations... etc.
- Another way to see Beziers is as a *weighted average* between the control points.

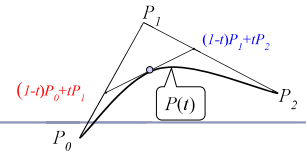

86

Bernstein polynomials

$$P(t) = \underbrace{(1-t)^3}_{b_{0,3}(t)} P_0 + \underbrace{3t(1-t)^2}_{b_{1,3}(t)} P_1 + \underbrace{3t^2(1-t)}_{b_{2,3}(t)} P_2 + \underbrace{t^3}_{b_{3,3}(t)} P_3$$

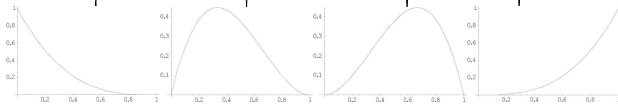

- The four control functions are the four *Bernstein polynomials* for $n=3$.

- General form: $b_{v,n}(t) = \binom{n}{v} t^v (1-t)^{n-v}$
- Bernstein polynomials in $0 \leq t \leq 1$ always sum to 1:

$$\sum_{v=1}^n \binom{n}{v} t^v (1-t)^{n-v} = (t + (1-t))^n = 1$$

87

Drawing a Bezier cubic: Iterative method

Fixed-step iteration:

- Draw as a set of short line segments equispaced in parameter space, t :

```
(x0,y0) = Bezier(0)
FOR t = 0.05 TO 1 STEP 0.05 DO
  (x1,y1) = Bezier(t)
  DrawLine( (x0,y0), (x1,y1) )
  (x0,y0) = (x1,y1)
END FOR
```

- Problems:
 - Cannot fix a number of segments that is appropriate for all possible Beziers: too many or too few segments
 - distance in real space, (x,y) , is not linearly related to distance in parameter space, t

88

Drawing a Bezier cubic

...but not very well

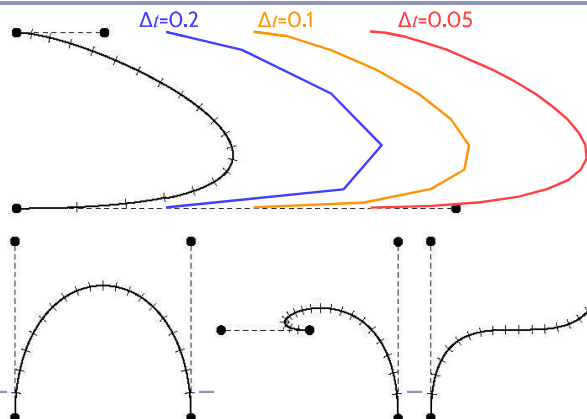

89

Drawing a Bezier cubic: Adaptive method

- Subdivision:
 - check if a straight line between P_0 and P_3 is an adequate approximation to the Bezier
 - if so: draw the straight line
 - if not: divide the Bezier into two halves, each a Bezier, and repeat for the two new Beziers
- Need to specify some tolerance for when a straight line is an adequate approximation
 - when the Bezier lies within half a pixel width of the straight line along its entire length

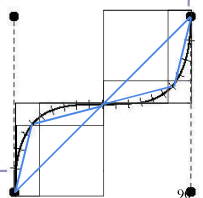

90

Drawing a Bezier cubic: Adaptive method (continued)

```

Procedure DrawCurve( Bezier curve )
VAR Bezier left, right
BEGIN DrawCurve
  IF Flat(curve) THEN
    DrawLine(curve)
  ELSE
    SubdivideCurve(curve, left, right)
    DrawCurve(left)
    DrawCurve(right)
  END IF
END DrawCurve
    
```

e.g. if P_1 and P_2 both lie within half a pixel width of the line joining P_0 to P_3 , then...

...draw a line from P_0 to P_3 ; otherwise,

...split the curve into two Beziers covering the first and second halves of the original and draw recursively

91

Checking for flatness

$$P(t) = (1-t)A + tB$$

$$AB \cdot CP(t) = 0$$

$$\rightarrow (x_B - x_A)(x_P - x_C) + (y_B - y_A)(y_P - y_C) = 0$$

$$\rightarrow t = \frac{(x_B - x_A)(x_C - x_A) + (y_B - y_A)(y_C - y_A)}{(x_B - x_A)^2 + (y_B - y_A)^2}$$

$$\rightarrow t = \frac{AB \cdot AC}{|AB|^2}$$

Careful! If $t < 0$ or $t > 1$, use $|AC|$ or $|BC|$ respectively.

we need to know this distance

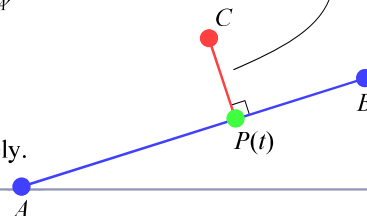

92

Subdividing a Bezier cubic in two

To split a Bezier cubic into two smaller Bezier cubics:

$$\begin{array}{ll}
 Q_0 = P_0 & R_3 = \frac{1}{8}P_0 + \frac{3}{8}P_1 + \frac{3}{8}P_2 + \frac{1}{8}P_3 \\
 Q_1 = \frac{1}{2}P_0 + \frac{1}{2}P_1 & R_2 = \frac{1}{4}P_1 + \frac{1}{2}P_2 + \frac{1}{4}P_3 \\
 Q_2 = \frac{1}{4}P_0 + \frac{1}{2}P_1 + \frac{1}{4}P_2 & R_1 = \frac{1}{2}P_2 + \frac{1}{2}P_3 \\
 Q_3 = \frac{1}{8}P_0 + \frac{3}{8}P_1 + \frac{3}{8}P_2 + \frac{1}{8}P_3 & R_0 = P_3
 \end{array}$$

These cubics will lie atop the halves of their parent exactly, so rendering them = rendering the parent.

93

Drawing a Bezier cubic: Signed Distance Fields

1. Iterative implementation

$SDF(P) = \min(\text{distance from } P \text{ to each of } n \text{ line segments})$

- In the demo, 50 steps suffices

2. Adaptive implementation

$SDF(P) = \min(\text{distance to each sub-curve whose bounding box contains } P)$

- Can fast-discard sub-curves whose bbox doesn't contain P
- In the demo, 25 subdivisions suffices

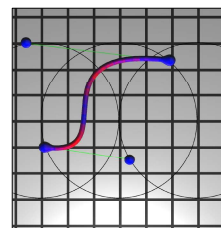
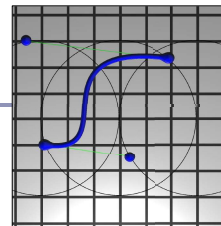

94

Overhauser's cubic

Overhauser's cubic: a Bezier cubic which passes through four target data points

- Calculate the appropriate Bezier control point locations from the given data points
 - e.g. given points A, B, C, D, the Bezier control points are:
 - $P_0 = B$ $P_1 = B + (C-A)/6$
 - $P_3 = C$ $P_2 = C - (D-B)/6$
- Overhauser's cubic *interpolates* its controlling points
 - good for animation, movies; less for CAD/CAM
 - moving a single point modifies four adjacent curve segments
 - compare with Bezier, where moving a single point modifies just the two segments connected to that point

95

Types of curve join

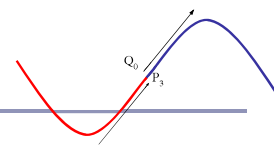

- each curve is smooth within itself
- joins at endpoints can be:
 - C_1 – continuous in both position and tangent vector
 - smooth join in a mathematical sense
 - G_1 – continuous in position, tangent vector in same direction
 - smooth join in a geometric sense
 - C_0 – continuous in position only
 - “corner”
 - discontinuous in position

C_n (mathematical continuity): continuous in all derivatives up to the n^{th} derivative

G_n (geometric continuity): each derivative up to the n^{th} has the same “direction” to its vector on either side of the join

$$C_n \Rightarrow G_n$$

96

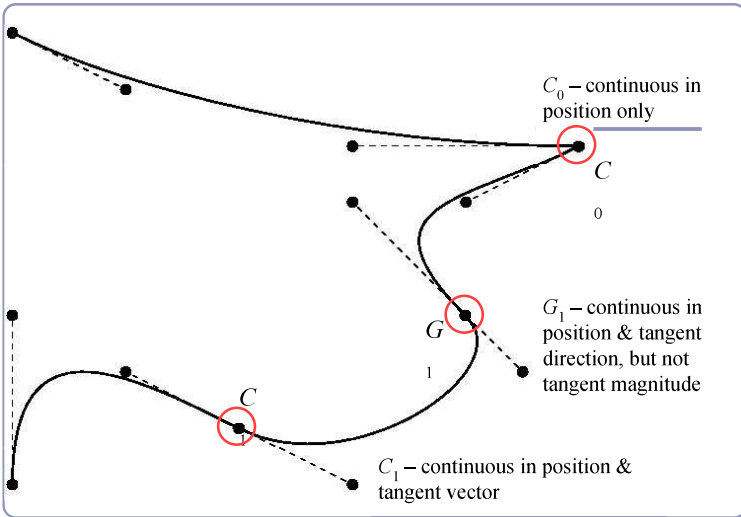

97

Joining Bezier splines

- To join two Bezier splines with C_0 continuity, set $P_3 = Q_0$.
- To join two Bezier splines with C_1 continuity, require C_0 and make the tangent vectors equal: set $P_3 = Q_0$ and $P_3 - P_2 = Q_1 - Q_0$.

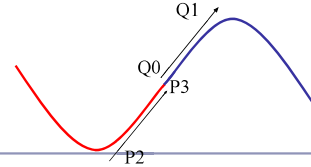

98

What if we want to chain Bezier together?

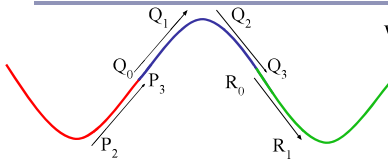

We can parameterize this chain over t by saying that instead of going from 0 to 1, t moves smoothly through the intervals $[0,1,2,3]$

Consider a chain of splines with many control points...

$$P = \{P_0, P_1, P_2, P_3\}$$

$$Q = \{Q_0, Q_1, Q_2, Q_3\}$$

$$R = \{R_0, R_1, R_2, R_3\}$$

...with C_1 continuity...

$$P_3 = Q_0, P_2 - P_3 = Q_1 - Q_0$$

$$Q_3 = R_0, Q_2 - Q_3 = R_1 - R_0$$

The curve $C(t)$ would be:

$$C(t) = P(t) \cdot ((0 \leq t < 1) ? 1 : 0) +$$

$$Q(t-1) \cdot ((1 \leq t < 2) ? 1 : 0) +$$

$$R(t-2) \cdot ((2 \leq t < 3) ? 1 : 0)$$

$[0,1,2,3]$ is a type of *knot vector*.
0, 1, 2, and 3 are the *knots*.

99

B-Splines and NURBS

- A Bezier cubic is a polynomial of degree three: it must have four control points, it must begin at the first and end at the fourth, and it assumes that all four control points are equally important.
- B-spline* curves are a piecewise parameterization of a series of splines, that supports an arbitrary number of control points and lets you specify the degree of the polynomial which interpolates them.
- NURBS* ("Non-Uniform Rational B-Splines") are a generalization of Bezier.
 - NU: *Non-Uniform*. The knots in the knot vector are not required to be uniformly spaced.
 - R: *Rational*. The spline may be defined by rational polynomials (homogeneous coordinates.)
 - BS: *B-Spline*. A generalized Bezier spline with controllable degree.

100

Bezier patch definition

The Bezier patch defined by sixteen control points,

$$P_{0,0} \dots P_{0,3}$$

$$\vdots$$

$$P_{3,0} \dots P_{3,3}$$

is:

$$P(s, t) = \sum_{i=0}^3 \sum_{j=0}^3 b_i(s) b_j(t) P_{ij}$$

Compare this to the 2D version:

$$P(t) = \sum_{i=0}^3 b_i(t) P_i$$

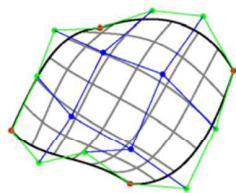

101

Bezier patches

- If curve A has n control points and curve B has m control points then $A \otimes B$ is an $(n) \times (m)$ matrix of polynomials of degree $\max(n-1, m-1)$.
 - \otimes = tensor product
- Multiply this matrix against an $(n) \times (m)$ matrix of control points and sum them all up and you've got a bivariate expression for a rectangular surface patch, in 3D
- This approach generalizes to triangles and arbitrary n -gons.

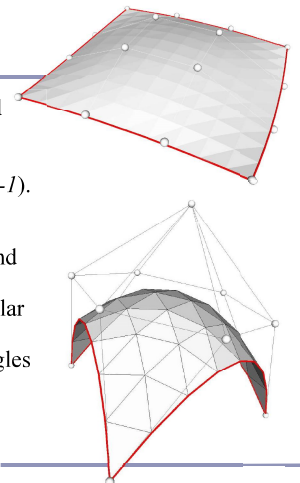

102

Tensor product

- The *tensor product* of two vectors is a matrix.

$$\begin{bmatrix} a \\ b \\ c \end{bmatrix} \otimes \begin{bmatrix} d \\ e \\ f \end{bmatrix} = \begin{bmatrix} ad & ae & af \\ bd & be & bf \\ cd & ce & cf \end{bmatrix}$$

- Can take the tensor of two polynomials.
 - Each coefficient represents a piece of each of the two original expressions, so the cumulative polynomial represents both original polynomials completely.

103

Continuity between Bezier patches

Ensuring continuity in 3D:

- C0 – continuous in position
 - the four edge control points must match
- C1 – continuous in position and tangent vector
 - the four edge control points must match
 - the two control points on either side of each of the four edge control points must be co-linear with both the edge point, and each other, *and* be equidistant from the edge point
- G1 – continuous in position and tangent direction
 - the four edge control points must match
 - the relevant control points must be co-linear

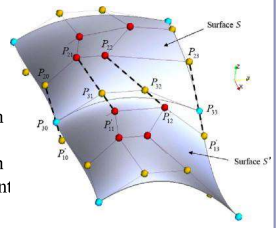

Image credit: Olivier Czarny, Guido Huysmans. *Bézier surfaces and finite elements for MHD simulations*. Journal of Computational Physics Volume 227, Issue 16, 10 August 2008

104

References

- Les Piegl and Wayne Tiller, *The NURBS Book*, Springer (1997)
- Alan Watt, *3D Computer Graphics*, Addison Wesley (2000)
- G. Farin, J. Hoschek, M.-S. Kim, *Handbook of Computer Aided Geometric Design*, North-Holland (2002)

105



Further Graphics

Subdivision Surfaces

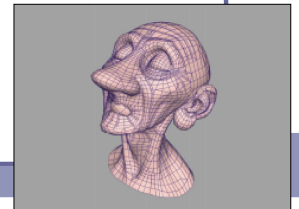

Alex Benton, University of Cambridge – alex@bentonian.com
Supported in part by Google UK, Ltd

106

Problems with Bezier (NURBS) patches

- Joining spline patches with C_n continuity across an edge is challenging.
- What happens to continuity at corners where the number of patches meeting isn't exactly four?
- Animation is tricky: bending and blending are doable, but not easy.

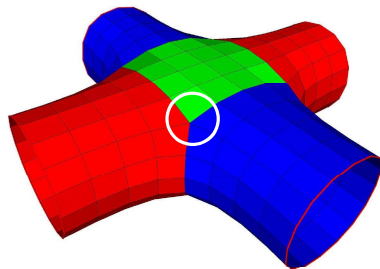

Sadly, the world isn't made up of shapes that can always be made from one smoothly-deformed rectangular surface.

107

Subdivision surfaces

- Beyond shipbuilding: we want guaranteed continuity, without having to build everything out of rectangular patches.
 - Applications include CAD/CAM, 3D printing, museums and scanning, medicine, movies...
- The solution: *subdivision surfaces*.



Geri's Game, by Pixar (1997)

108

Subdivision surfaces

- Instead of ticking a parameter t along a parametric curve (or the parameters u, v over a parametric grid), subdivision surfaces repeatedly refine from a coarse set of *control points*.
- Each step of refinement adds new faces and vertices.
- The process converges to a smooth *limit surface*.

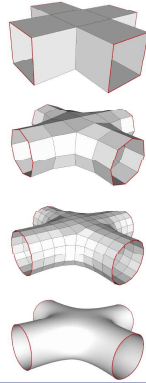

(Catmull-Clark in action)

Subdivision surfaces – History

- de Rahm described a 2D (curve) subdivision scheme in 1947; rediscovered in 1974 by Chaikin
- Concept extended to 3D (surface) schemes by two separate groups during 1978:
 - Doo and Sabin found a biquadratic surface
 - Catmull and Clark found a bicubic surface
- Subsequent work in the 1980s (Loop, 1987; Dyn [Butterfly subdivision], 1990) led to tools suitable for CAD/CAM and animation

110

Subdivision surfaces and the movies

- Pixar first demonstrated subdivision surfaces in 1997 with Geri's Game.
 - Up until then they'd done everything in NURBS (Toy Story, A Bug's Life.)
 - From 1999 onwards everything they did was with subdivision surfaces (Toy Story 2, Monsters Inc, Finding Nemo...)
 - Two decades on, it's all heavily customized.
- It's not clear what Dreamworks uses, but they have recent patents on subdivision techniques.

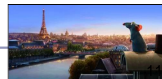

Useful terms

- A scheme which describes a 1D curve (even if that curve is travelling in 3D space, or higher) is called *univariate*, referring to the fact that the limit curve can be approximated by a polynomial in one variable (t).
- A scheme which describes a 2D surface is called *bivariate*, the limit surface can be approximated by a u, v parameterization.
- A scheme which retains and passes through its original control points is called an *interpolating* scheme.
- A scheme which moves away from its original control points, converging to a limit curve or surface nearby, is called an *approximating* scheme.

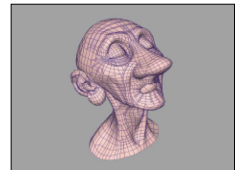

Control surface for Geri's head

112

How it works

- Example: *Chaikin* curve subdivision (2D)
 - On each edge, insert new control points at $\frac{1}{4}$ and $\frac{3}{4}$ between old vertices; delete the old points
 - The *limit curve* is C1 everywhere (despite the poor figure.)

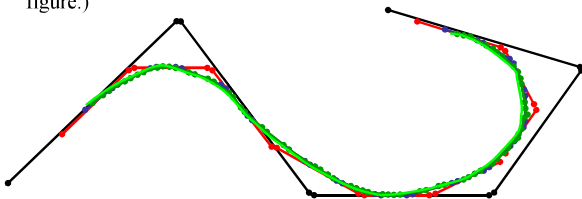

113

Notation

Chaikin can be written programmatically as:

$$\begin{array}{l}
 P_i^k \quad P_{2i}^{k+1} = \left(\frac{3}{4}\right)P_i^k + \left(\frac{1}{4}\right)P_{i+1}^k \quad \leftarrow \text{Even} \\
 P_{2i+1}^{k+1} \quad P_{2i+1}^{k+1} = \left(\frac{1}{4}\right)P_i^k + \left(\frac{3}{4}\right)P_{i+1}^k \quad \leftarrow \text{Odd}
 \end{array}$$

...where k is the 'generation'; each generation will have twice as many control points as before.

Notice the different treatment of generating odd and even control points.

Borders (terminal points) are a special case.

114

Notation

Chaikin can be written in vector notation as:

$$\begin{bmatrix} \vdots \\ P_{2i-2}^{k+1} \\ P_{2i-1}^{k+1} \\ P_{2i}^{k+1} \\ P_{2i+1}^{k+1} \\ P_{2i+2}^{k+1} \\ P_{2i+3}^{k+1} \\ \vdots \end{bmatrix} = \frac{1}{4} \begin{bmatrix} \vdots \\ 0 & 3 & 1 & 0 & 0 & 0 \\ 0 & 1 & 3 & 0 & 0 & 0 \\ 0 & 0 & 3 & 1 & 0 & 0 \\ 0 & 0 & 1 & 3 & 0 & 0 \\ 0 & 0 & 0 & 3 & 1 & 0 \\ 0 & 0 & 0 & 1 & 3 & 0 \\ \vdots \end{bmatrix} \begin{bmatrix} \vdots \\ P_{i-2}^k \\ P_{i-1}^k \\ P_i^k \\ P_{i+1}^k \\ P_{i+2}^k \\ P_{i+3}^k \\ \vdots \end{bmatrix}$$

115

Notation

- The standard notation compresses the scheme to a *kernel*:
 - $h=(1/4)[\dots,0,0,1,3,3,1,0,0,\dots]$
- The kernel interlaces the odd and even rules.
- It also makes matrix analysis possible: eigenanalysis of the matrix form can be used to prove the continuity of the subdivision limit surface.
 - The details of analysis are fascinating, lengthy, and sadly beyond the scope of this course
- The limit curve of Chaikin is a quadratic B-spline!

116

Reading the kernel

Consider the kernel

$$h=(1/8)[\dots,0,0,1,4,6,4,1,0,0,\dots]$$

You would read this as

$$P_{2i}^{k+1} = (1/8)(P_{i-1}^k + 6P_i^k + P_{i+1}^k)$$

$$P_{2i+1}^{k+1} = (1/8)(4P_i^k + 4P_{i+1}^k)$$

The limit curve is provably C2-continuous.

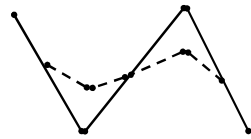

117

Making the jump to 3D: Doo-Sabin

Doo-Sabin takes Chaikin to 3D:

$$\begin{aligned} P &= (9/16)A + \\ & (3/16)B + \\ & (3/16)C + \\ & (1/16)D \end{aligned}$$

This replaces every old vertex with four new vertices.

The limit surface is biquadratic, C1 continuous everywhere.

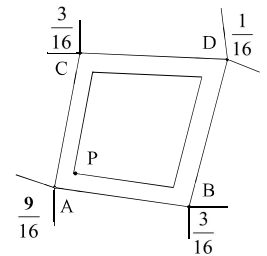

118

Doo-Sabin in action

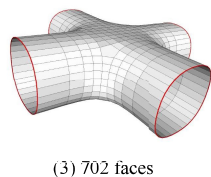
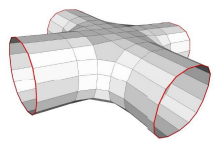
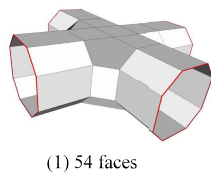
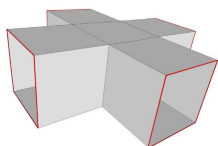

119

Catmull-Clark

- Catmull-Clark* is a bivariate approximating scheme with kernel $h=(1/8)[1,4,6,4,1]$.
 - Limit surface is bicubic, C2-continuous.

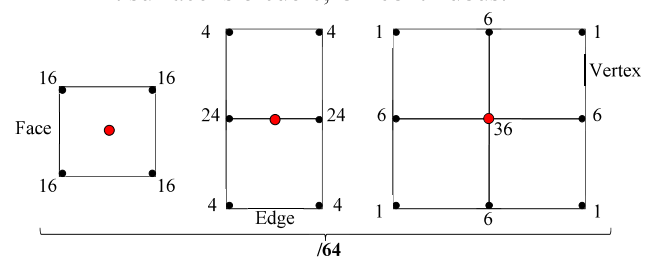

120

Catmull-Clark

Getting tensor again:

$$\frac{1}{8} \begin{bmatrix} 1 \\ 4 \\ 6 \\ 4 \\ 1 \end{bmatrix} \otimes \frac{1}{8} \begin{bmatrix} 1 \\ 4 \\ 6 \\ 4 \\ 1 \end{bmatrix} = \frac{1}{64} \begin{bmatrix} 1 & 4 & 6 & 4 & 1 \\ 4 & 16 & 24 & 16 & 4 \\ 6 & 24 & 36 & 24 & 6 \\ 4 & 16 & 24 & 16 & 4 \\ 1 & 4 & 6 & 4 & 1 \end{bmatrix}$$

Vertex rule Face rule Edge rule

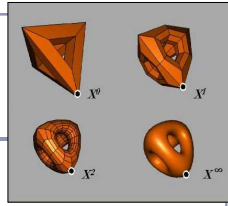

Catmull-Clark in action

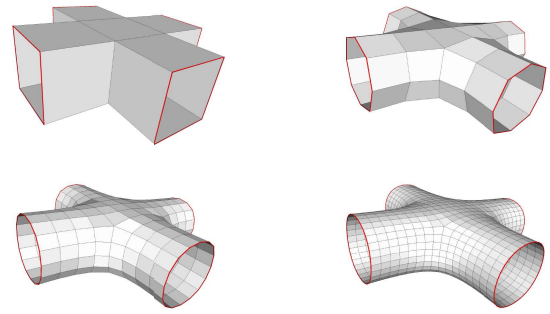

Catmull-Clark vs Doo-Sabin

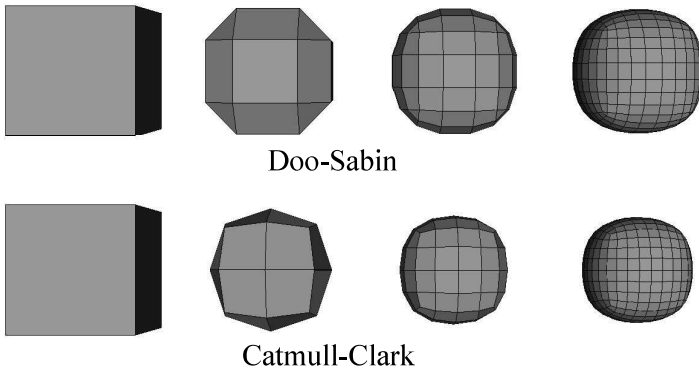

Extraordinary vertices

- Catmull-Clark and Doo-Sabin both operate on quadrilateral meshes.
 - All faces have four boundary edges
 - All vertices have four incident edges
- What happens when the mesh contains extraordinary vertices or faces?
 - For many schemes, adaptive weights exist which can continue to guarantee at least some (non-zero) degree of continuity, but not always the best possible.
- CC replaces extraordinary faces with extraordinary vertices; DS replaces extraordinary vertices with extraordinary faces.

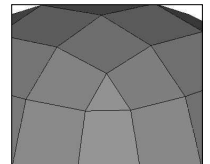
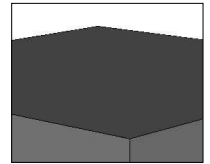

Detail of Doo-Sabin at cube corner

Extraordinary vertices: Catmull-Clark

Catmull-Clark vertex rules generalized for extraordinary vertices:

- Original vertex: $(4n-7) / 4n$
- Immediate neighbors in the one-ring: $3/2n^2$
- Interleaved neighbors in the one-ring: $1/4n^2$

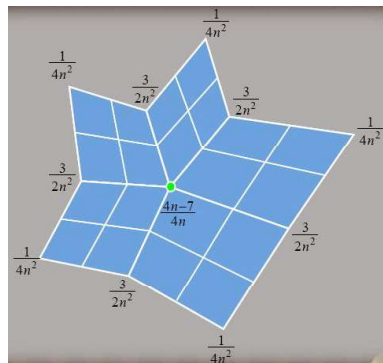
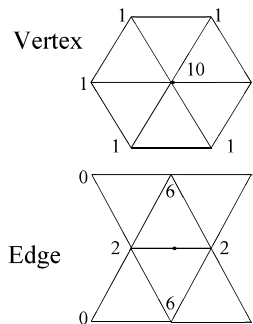

Image source: "Next-Generation Rendering of Subdivision Surfaces". Ignacio Castaño, SIGGRAPH 2008

Schemes for simplicial (triangular) meshes

- Loop scheme:



- Butterfly scheme:

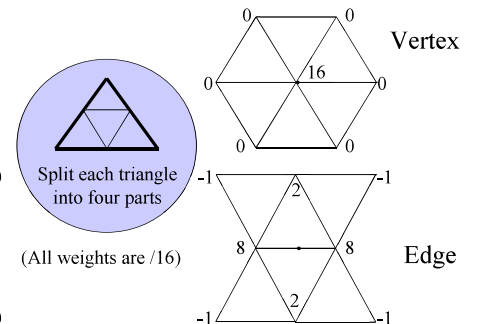

Loop subdivision

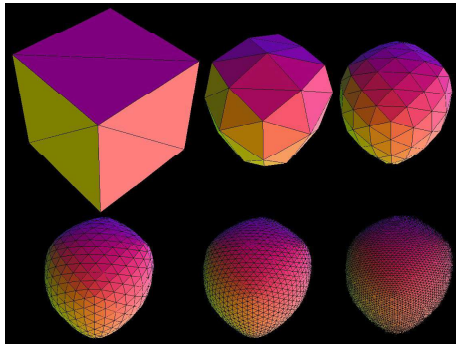

Loop subdivision in action. The asymmetry is due to the choice of face diagonals.

Image by Matt Fisher, <http://www.its.caltech.edu/~mathewf/Chatter/Subdivision.html>

127

Creases

Extensions exist for most schemes to support *creases*, vertices and edges flagged for partial or hybrid subdivision.

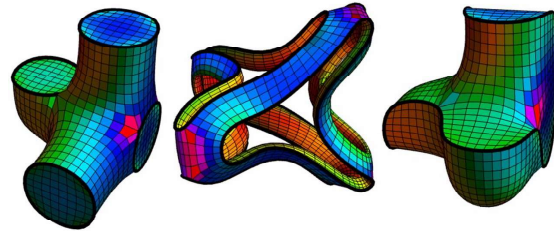

Still from "Volume Enclosed by Subdivision Surfaces with Sharp Creases" by Jan Hakenberg, Ulrich Reif, Scott Schaefer, Joe Warren <http://visra.org/pdf/1406.0060v1.pdf>

128

Continuous level of detail

For live applications (e.g. games) can compute *continuous* level of detail, typically as a function of distance:

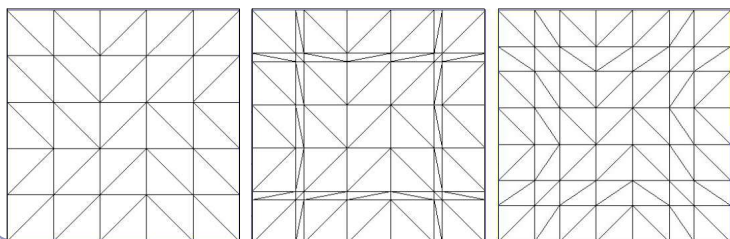

Level 5

Level 5.2

Level 5.8

129

Direct evaluation of the limit surface

- In the 1999 paper *Exact Evaluation Of Catmull-Clark Subdivision Surfaces at Arbitrary Parameter Values*, Jos Stam (now at Alias|Wavefront) describes a method for finding the exact final positions of the CC limit surface.
 - His method is based on calculating the tangent and normal vectors to the limit surface and then shifting the control points out to their final positions.
 - What's particularly clever is that he gives exact evaluation at the extraordinary vertices. (Non-trivial.)

130

Bounding boxes and convex hulls for subdivision surfaces

- The limit surface is (the weighted average of (the weighted averages of (the weighted averages of (repeat for eternity...)))) the original control points.
- This implies that for any scheme where all weights are positive and sum to one, the limit surface lies entirely within the convex hull of the original control points.
- For schemes with negative weights:
 - Let $L = \max \sum_i |N_i(t)|$ be the greatest sum throughout parameter space of the absolute values of the weights.
 - For a scheme with negative weights, L will exceed 1.
 - Then the limit surface must lie within the convex hull of the original control points, expanded unilaterally by a ratio of $(L-1)$.

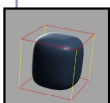

131

Splitting a subdivision surface

Many algorithms rely on subdividing a surface and examining the bounding boxes of smaller facets.

- Rendering, ray/surface intersections...

It's not enough just to delete half your control points: the limit surface will change (see right)

- Need to include all control points from the previous generation, which influence the limit surface in this smaller part.

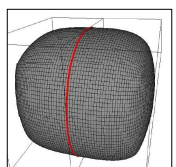
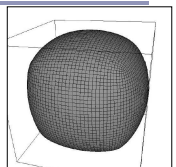

(Top) 5x Catmull-Clark subdivision of a cube
(Bottom) 5x Catmull-Clark subdivision of two halves of a cube; the limit surfaces are clearly different.

132

Subdivision Schemes—A partial list

- Approximating
 - Quadrilateral
 - (1/2)[1,2,1]
 - (1/4)[1,3,3,1] (Doo-Sabin)
 - (1/8)[1,4,6,4,1] (Catmull-Clark)
 - Mid-Edge
 - Triangles
 - Loop
 - Interpolating
 - Quadrilateral
 - Kobbelt
 - Triangle
 - Butterfly
 - “√3” Subdivision
- Many more exist, some much more complex
This is a major topic of ongoing research

133

References

- Catmull, E., and J. Clark. “Recursively Generated B-Spline Surfaces on Arbitrary Topological Meshes.” *Computer Aided Design*, 1978.
- Dyn, N., J. A. Gregory, and D. A. Levin. “Butterfly Subdivision Scheme for Surface Interpolation with Tension Control.” *ACM Transactions on Graphics*. Vol. 9, No. 2 (April 1990): pp. 160–169.
- Halstead, M., M. Kass, and T. DeRose. “Efficient, Fair Interpolation Using Catmull-Clark Surfaces.” *Siggraph '93*. p. 35.
- Zorin, D. “Stationary Subdivision and Multiresolution Surface Representations.” Ph.D. diss., California Institute of Technology, 1997
- Ignacio Castano, “Next-Generation Rendering of Subdivision Surfaces.” *Siggraph '08*, <http://developer.nvidia.com/object/siggraph-2008-Subdiv.html>
- Dennis Zorin’s SIGGRAPH course, “Subdivision for Modeling and Animation”, <http://www.mrl.nyu.edu/publications/subdiv-course2000/>

134

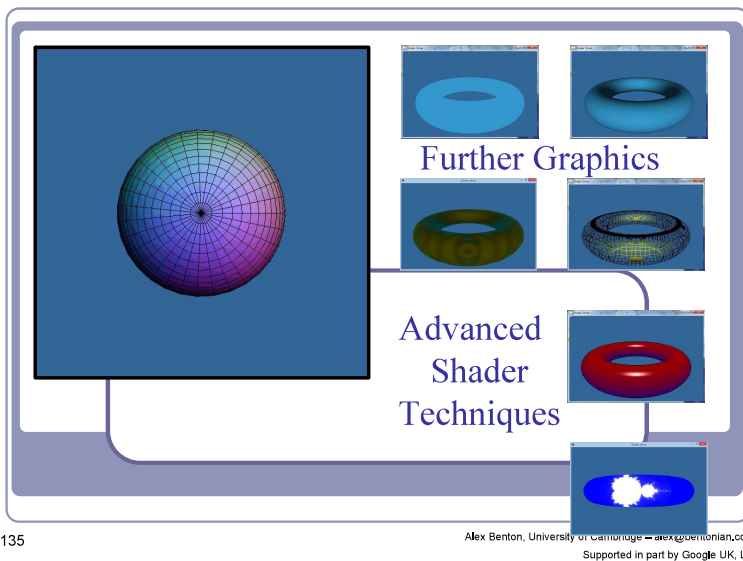

135

Alex Benton, University of Cambridge – alex@emeronian.com
Supported in part by Google UK, Ltd

Lighting and Shading (a quick refresher)

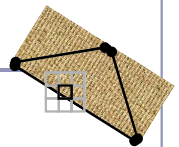

Recall the classic **lighting equation**:

$$I = k_A + k_D(N \cdot L) + k_S(E \cdot R)^n$$

where...

- k_A is the *ambient lighting coefficient* of the object or scene
- $k_D(N \cdot L)$ is the *diffuse component* of surface illumination (‘matte’)
- $k_S(E \cdot R)^n$ is the *specular component* of surface illumination (‘shiny’) where $R = L - 2(L \cdot N)N$

We compute color by vertex or by polygon fragment:

- Color at the vertex: **Gouraud shading**
- Color at the polygon fragment: **Phong shading**

Vertex shader outputs are interpolated across fragments, so code is clean whether we’re interpolating colors or normals.

136

Shading with shaders



For each vertex our Java code will need to provide:

- Vertex position
- Vertex normal
- [Optional] Vertex color, $k_A / k_D / k_S$, reflectance, transparency...

We also need global state:

- Camera position and orientation, represented as a transform
- Object position and orientation, to modify the vertex positions above
- A list of light positions, ideally in world coordinates

137

Shader sample – Gouraud shading



```
#version 330

uniform mat4 modelToScreen;
uniform mat4 modelToWorld;
uniform mat3 normalToWorld;
uniform vec3 lightPosition;

in vec4 v;
in vec3 n;

out vec4 color;

const vec3 purple = vec3(0.2, 0.6, 0.8);

void main() {
    vec3 p = (modelToWorld * v).xyz;
    vec3 n = normalize(normalToWorld * n);
    vec3 l = normalize(lightPosition - p);
    float ambient = 0.2;
    float diffuse = 0.8 * clamp(0, dot(n, l), 1);

    color = vec4(purple
        * (ambient + diffuse), 1.0);
    gl_Position = modelToScreen * v;
}
```

```
#version 330

in vec4 color;

out vec4 fragmentColor;

void main() {
    fragmentColor = color;
}
```

Diffuse lighting
 $d = k_D(N \cdot L)$
expressed as a shader

138

Shader sample – Phong shading



```
#version 330
uniform mat4 modelToScreen;
uniform mat4 modelToWorld;
uniform mat3 normalToWorld;

in vec4 v;
in vec3 n;

out vec3 position;
out vec3 normal;

void main() {
    normal = normalize(
        normalToWorld * n);
    position =
        (modelToWorld * v).xyz;
    gl_Position =
        modelToScreen * v;
}

#version 330
uniform vec3 eyePosition;
uniform vec3 lightPosition;

in vec3 position;
in vec3 normal;

out vec4 fragmentColor;

const vec3 purple = vec3(0.2, 0.6, 0.8);

void main() {
    vec3 n = normalize(normal);
    vec3 l = normalize(lightPosition - position);
    vec3 e = normalize(position - eyePosition);
    vec3 r = reflect(l, n);

    float ambient = 0.2;
    float diffuse = 0.4 * clamp(0, dot(n, l), 1);
    float specular = 0.4 *
        pow(clamp(0, dot(e, r), 1), 2);

    fragmentColor = vec4(purple *
        (ambient + diffuse + specular), 1.0);
}
```

$$a = k_A$$

$$d = k_D(N \cdot L)$$

$$s = k_S(E \cdot R)^n$$

GLSL includes handy helper methods for illumination such as `reflect()`—perfect for specular highlights.

Shader sample – Gooch shading

Gooch shading is an example of *non-realistic rendering*. It was designed by Amy and Bruce Gooch to replace photorealistic lighting with a lighting model that highlights structural and contextual data.

- They use the term of the conventional lighting equation to choose a map between ‘cool’ and ‘warm’ colors.
- This is in contrast to conventional illumination where lighting simply scales the underlying surface color.
- Combined with edge-highlighting through a second render pass, this creates 3D models which look like engineering schematics.

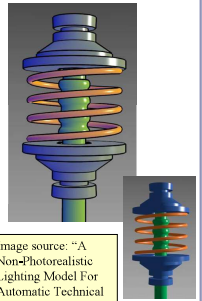

Image source: “A Non-Photorealistic Lighting Model For Automatic Technical Illustration”, Gooch, Gooch, Shirley and Cohen (1998). Compare the Gooch shader, above, to the Phong shader (right).

Shader sample – Gooch shading

```
#version 330
// Original author: Randi Rest
// Copyright (c) 2002-2005 3DLabs Inc. Ltd.

uniform mat4 modelToCamera;
uniform mat4 modelToScreen;
uniform mat3 normalToCamera;

vec3 LightPosition = vec3(10, 10, 4);

in vec4 vPosition;
in vec3 vNormal;

out float NdotL;
out vec3 ReflectVec;
out vec3 ViewVec;

void main() {
    vec3 ecPos = vec3(modelToCamera * vPosition);
    vec3 tnorm = normalize(normalToCamera * vNormal);
    vec3 lightVec = normalize(lightPosition - ecPos);
    ReflectVec = normalize(reflect(lightVec, tnorm));
    ViewVec = normalize(-ecPos);
    NdotL = dot(lightVec, tnorm) + 1.0 * 0.5;
    gl_Position = modelToScreen * vPosition;
}
```

```
#version 330
// Original author: Randi Rest
// Copyright (c) 2002-2005 3DLabs Inc. Ltd.

uniform vec3 vColor;

float DiffuseCool = 0.3;
float DiffuseWarm = 0.3;
vec3 Cool = vec3(0, 0, 0.6);
vec3 Warm = vec3(0.6, 0, 0);

in float NdotL;
in vec3 ReflectVec;
in vec3 ViewVec;

out vec4 result;

void main() {
    vec3 kcool = min(Cool + DiffuseCool * vColor, 1.0);
    vec3 kwarm = min(Warm + DiffuseWarm * vColor, 1.0);
    vec3 kfinal = mix(kcool, kwarm, NdotL);

    vec3 nRefl = normalize(ReflectVec);
    vec3 nView = normalize(ViewVec);
    float spec = pow(max(dot(nRefl, nView), 0.0), 32.0);

    if (gl_FrontFacing) {
        result = vec4(min(kfinal + spec, 1.0), 1.0);
    } else {
        result = vec4(0, 0, 0, 1);
    }
}
```

Shader sample – Gooch shading

In the vertex shader source, notice the use of the built-in ability to distinguish front faces from back faces:

```
if (gl_FrontFacing) {...}
```

This supports distinguishing front faces (which should be shaded smoothly) from the edges of back faces (which will be drawn in heavy black.)

In the fragment shader source, this is used to choose the weighted color by clipping with the a component:

```
vec3 kfinal = mix(kcool, kwarm, NdotL);
```

Here `mix()` is a GLSL method which returns the linear interpolation between `kcool` and `kwarm`. The weighting factor is `NdotL`, the lighting value.

Shader sample – Gooch shading

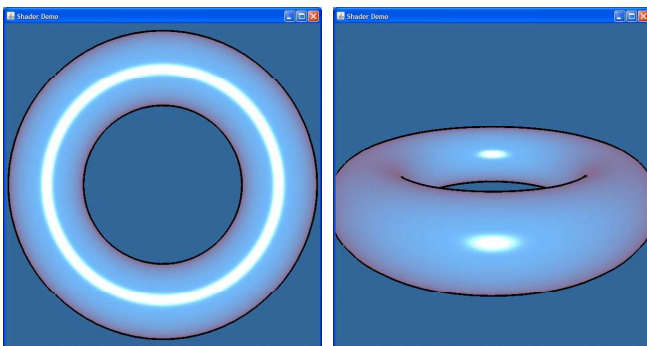

Texture mapping

Real-life objects rarely consist of perfectly smooth, uniformly colored surfaces.

Texture mapping is the art of applying an image to a surface, like a decal. Coordinates on the surface are mapped to coordinates in the texture.

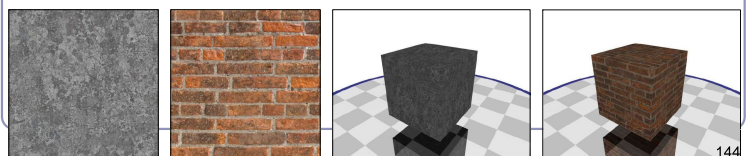

Procedural texture

Instead of relying on discrete pixels, you can get infinitely more precise results with procedurally generated textures. Procedural textures compute the color directly from the U,V coordinate without an image lookup. For example, here's the code for the torus' brick pattern (right):

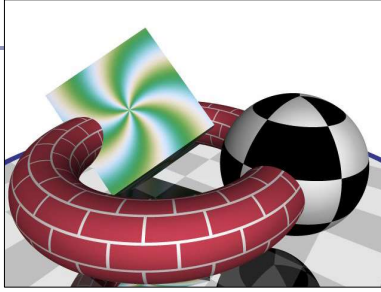

I've cheated slightly and multiplied the u coordinate by 4 to repeat the brick texture four times around the torus.

```
tx = (int) 10 * u
ty = (int) 10 * v
oddity = (tx & 0x01) == (ty & 0x01)
edge = ((10 * u - tx < 0.1) && oddity) || (10 * v - ty < 0.1)
return edge ? WHITE : RED
```

145

Non-color textures: normal mapping

Normal mapping applies the principles of texture mapping to the surface normal instead of surface color.

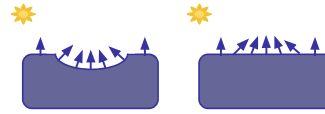

The specular and diffuse shading of the surface varies with the normals in a dent on the surface.

If we duplicate the normals, we don't have to duplicate the dent.

In a sense, the renderer computes a trompe-l'oeuil image on the fly and 'paints' the surface with more detail than is actually present in the geometry.

146

Non-color textures: normal mapping

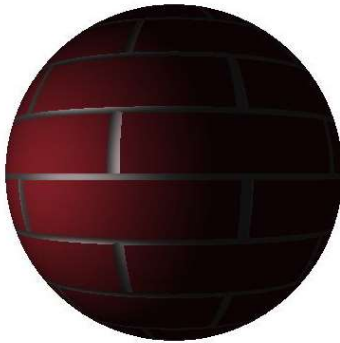

147

Procedural texturing in the fragment shader

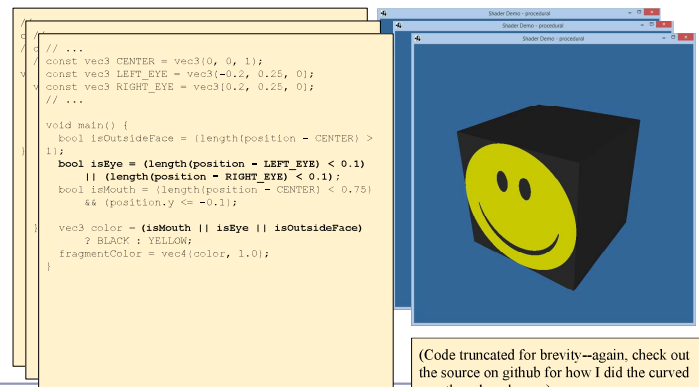

(Code truncated for brevity--again, check out the source on github for how I did the curved mouth and oval eyes.)

148

Advanced surface effects

- Ray-tracing, ray-marching!
- Specular highlights
- Non-photorealistic illumination
- Volumetric textures
- Bump-mapping
- Interactive surface effects
- Ray-casting in the shader
- Higher-order math in the shader
- ...much, much more!

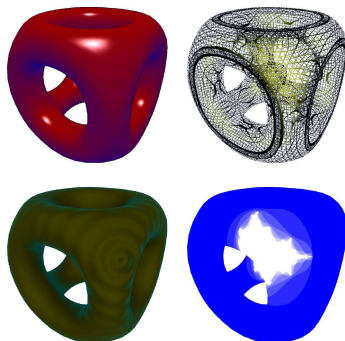

149

Antialiasing with OpenGL

Antialiasing remains a challenge with hardware-rendered graphics, but image quality can be significantly improved through GPU hardware.

- The simplest form of hardware anti-aliasing is Multi-Sample Anti-Aliasing (MSAA).
- "Render everything at higher resolution, then down-sample the image to blur jaggies"
- Enable MSAA in OpenGL with `glfwWindowHint(GLFW_SAMPLES, 4);`

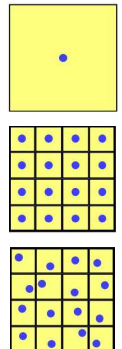

150

Antialiasing with OpenGL: MSAA

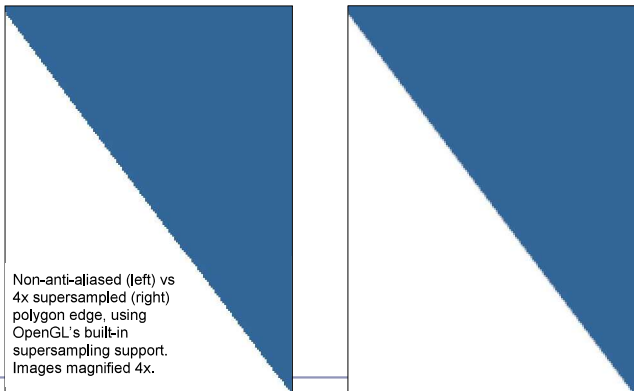

151

Antialiasing on the GPU

MSAA suffers from high memory constraints, and can be very limiting in high-resolution scenarios (high demand for time and texture access bandwidth.)

Eric Chan at MIT described an optimized hardware-based anti-aliasing method in 2004:

1. Draw the scene normally
2. Draw wide lines at the objects' silhouettes
 - Use blurring filters and precomputed luminance tables to blur the lines' width
3. Composite the filtered lines into the framebuffer using alpha blending

This approach is great for polygonal models, tougher for effects-heavy visual scenes like video games

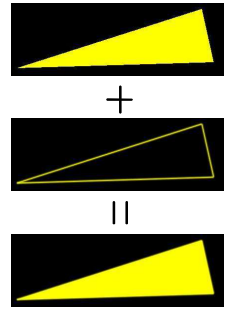

152

Antialiasing on the GPU

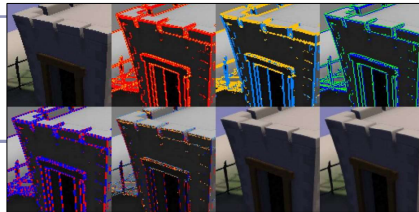

More recently, NVIDIA's *Fast Approximate Anti-Aliasing* ("FXAA") has become popular because it optimizes MSAA's limitations.

Abstract:

1. Use local contrast (pixel-vs-pixel) to find edges (red), especially those subject to aliasing.
2. Map these to horizontal (gold) or vertical (blue) edges.
3. Given edge orientation, the highest contrast pixel pair 90 degrees to the edge is selected (blue/green)
4. Identify edge ends (red/blue)
5. Re-sample at higher resolution along identified edges, using sub-pixel offsets of edge orientations
6. Apply a slight blurring filter based on amount of detected sub-pixel aliasing

Image from https://developer.download.nvidia.com/assets/gameworks/files/sdx/1/FXAA_WhitePaper.pdf

155

Preventing aliasing in texture reads

Antialiasing technique: *adaptive analytic prefiltering*.

- The precision with which an edge is rendered to the screen is dynamically refined based on the rate at which the function defining the edge is changing with respect to the surrounding pixels on the screen.

This is supported in GLSL by the methods $dFdx(F)$ and $dFdy(F)$.

- These methods return the derivative with respect to X and Y, *in screen space*, of some variable F.
- These are commonly used in choosing the filter width for antialiasing procedural textures.

(A) Jagged lines visible in the box function of the procedural stripe texture
 (B) Fixed-width averaging blends adjacent samples in texture space; aliasing still occurs at the top, where adjacency in texture space does not align with adjacency in pixel space.
 (C) Adaptive analytic prefiltering smoothly samples both areas.
 Image source: Figure 17.4, p. 440, *OpenGL Shading Language, Second Edition*, Randi Rost, Addison Wesley, 2006. Digital image scanned by Google Books.
 Original image by Bert Freudenberg, University of Magdeburg, 2002.



154

Antialiasing texture reads with Signed Distance Fields

Conventional anti-aliasing in texture reads can only smooth pixels immediately adjacent to the source values.

Signed distance fields represent monochrome texture data as a distance map instead of as pixels. This allows per-pixel smoothing at multiple distances.

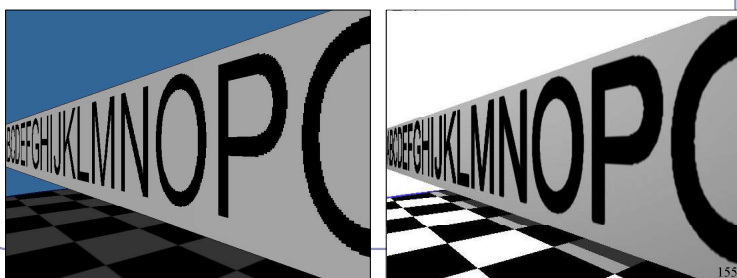

155

Antialiasing texture reads with Signed Distance Fields

The bitmap becomes a height map.

Each pixel stores the distance to the closest black pixel (if white) or white pixel (if black). Distance from white is negative.

3.6	2.8	2	1	-1
3.1	2.2	1.4	1	-1
2.8	2	1	-1	-1.4
2.2	1.4	1	-1	-2
2	1	-1	-1.4	-2.2
2	1	-1	-2	-2.8

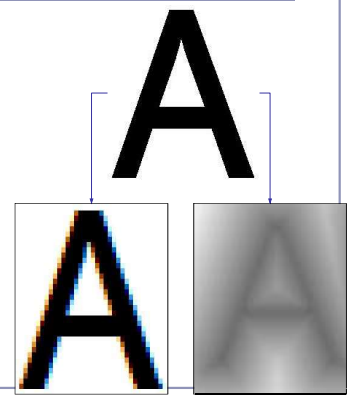

Conventional antialiasing

Signed distance field 156

Antialiasing texture reads with Signed Distance Fields

Conventional bilinear filtering computes a weighted average of color, but an SDF computes a weighted average of distances.

This means that a small step away from the original values we find smoother, straighter lines where the slope of the isocline is perpendicular to the slope of the source data.

By smoothing the isocline of the distance threshold, we achieve smoother edges and nifty edge effects.

```
low = 0.02;    high = 0.035;
double dist =
    bilinearSample(tex coords);
double t =
    (dist - low) / (high - low);
return (dist < low) ? BLACK
    : (dist > high) ? WHITE
    : BLACK*(1 - t) + WHITE*t;
```



Adding a second isocline enables colored borders.

157

Tessellation shaders

Tessellation is a new shader type introduced in OpenGL 4.x. Tessellation shaders generate new vertices within *patches*, transforming a small number of vertices describing triangles or quads into a large number of vertices which can be positioned individually.

One use of tessellation is in rendering geometry such as game models or terrain with view-dependent *Levels of Detail* ("LOD").

Another is to do with geometry what ray-tracing did with bump-mapping: high-precision realtime geometric deformation.

Note how triangles are small and detailed close to the camera, but get larger and coarser in the distance.

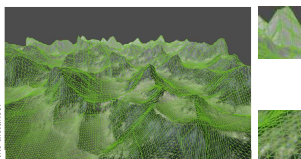

Florian Boesch's LOD terrain demo
<http://codeflow.ru/articles/2010/nov/07/opengl-4-tessellation/>

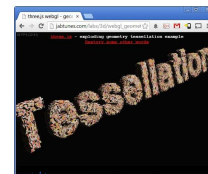

158

Tessellation shaders

How it works:

- You tell OpenGL how many vertices a single *patch* will have:
`glPatchParameteri(GL_PATCH_VERTICES, 4);`
- You tell OpenGL to render your patches:
`glDrawArrays(GL_PATCHES, first, numVerts);`
- The *Tessellation Control Shader* specifies output parameters defining how a patch is split up:
`gl_TessLevelOuter[]` and
`gl_TessLevelInner[]`.
 These control the number of vertices per primitive edge and the number of nested inner levels, respectively.

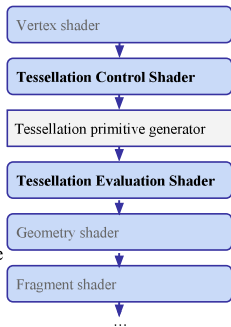

159

Tessellation shaders

The *tessellation primitive generator* generates new vertices along the outer edge and inside the patch, as specified by

`gl_TessLevelOuter[]` and
`gl_TessLevelInner[]`.

Each field is an array. Within the array, each value sets the number of intervals to generate during subprimitive generation.

Triangles are indexed similarly, but only use the first three *Outer* and the first *Inner* array field.

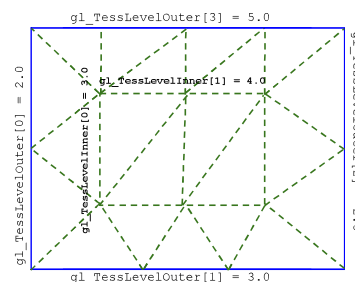

160

Tessellation shaders



The generated vertices are then passed to the *Tessellation Evaluation Shader*, which can update vertex position, color, normal, and all other per-vertex data.

Ultimately the complete set of new vertices is passed to the geometry and fragment shaders.

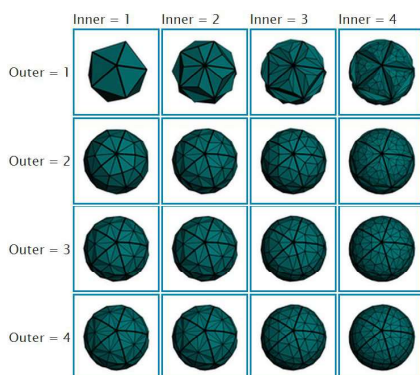

Image credit: Philip Rideout
<http://rideout.net/blog/?p=48>

CPU vs GPU – an object demonstration



"NVIDIA: Mythbusters - CPU vs GPU"

<https://www.youtube.com/watch?v=-P28LKWTzrf>

162

Recommended reading

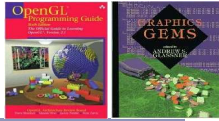

Course source code on Github -- many demos
<https://github.com/AlexBenton/AdvancedGraphics>

The OpenGL Programming Guide (2013), by Shreiner, Sellers, Kessenich and Licea-Kane

Some also favor *The OpenGL Superbible* for code samples and demos

There's also an OpenGL-ES reference, same series

OpenGL Insights (2012), by Cozzi and Riccio

OpenGL Shading Language (2009), by Rost, Licea-Kane, Ginsburg et al

The *Graphics Gems* series from Glassner

Anti-Aliasing:

<https://people.csail.mit.edu/ericchan/articles/prefilter/>

https://developer.download.nvidia.com/assets/gamedev/files/sdk/11/FXAA_WhitePaper.pdf

<http://rvoku.com/aacourse/downloads/09-FXAA-3.11-in-15-Slides.pdf>

163

Further Graphics



Global Illumination

Alex Benton, University of Cambridge - alex@bentonian.com
 Supported in part by Google UK, Ltd

164

Anisotropic shading

Anisotropic shading occurs in nature when light reflects off a surface differently in one direction from another, as a function of the surface itself. The specular component is modified by the direction of the light.



http://www.blender.org/wiki/Video:Introduction_to_anisotropic_shading

165

The rendering equation

Reflected light BRDF Incident light Integral over the hemisphere of incident light

$$L_r(\omega_r) = \int_{\Omega} \rho(\omega_i, \omega_r) L_i(\omega_i) \cos\theta_i d\omega_i$$

$$\omega_i = [\phi_i, \theta_i]$$

Most rendering methods require solving an (approximation) of the rendering equation

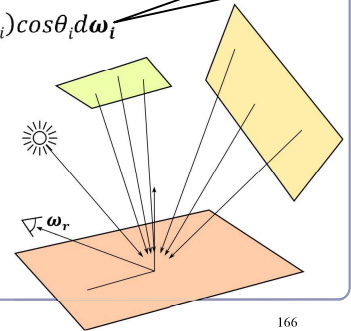

166

BRDF: Bidirectional Reflectance Distribution Function

Differential radiance of reflected light

$$\rho(\omega_i, \omega_r) = \frac{dL_r(\omega_r)}{dH_i(\omega_i)} = \frac{dL_r(\omega_r)}{L_i(\omega_i) \cos\theta_i d\omega_i}$$

Differential irradiance of incoming light

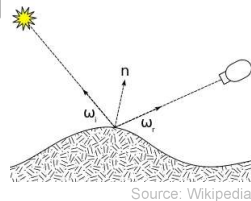

Source: Wikipedia

BRDF is measured as a ratio of *reflected radiance* to *irradiance*

- Because it is difficult to measure $L_i(\omega_i)$, it's impractical to define BRDF simply as the ratio of $L_r(\omega_r)$ to $L_i(\omega_i)$

167

BRDF of various materials

Incident light

Reflected light

These diagrams show the distribution of reflected light for the given incoming direction

The material samples are close but not accurate matches for the diagrams

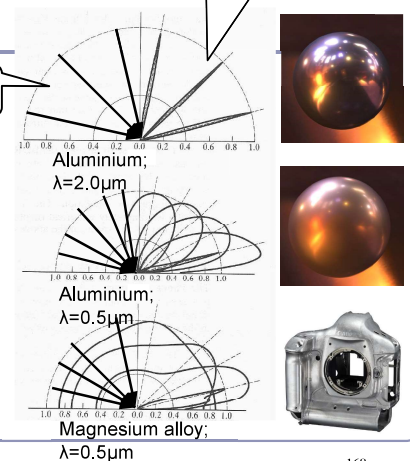

168

Measuring BRDF

- Gonio-Reflectometer
- BRDF measurement
 - point light source position (θ, ϕ)
 - light detector position (θ_o, ϕ_o)
- 4 directional degrees of freedom
- BRDF representation
 - m incident direction samples (θ, ϕ)
 - n outgoing direction samples (θ_o, ϕ_o)
 - $m*n$ reflectance values (large!!!)

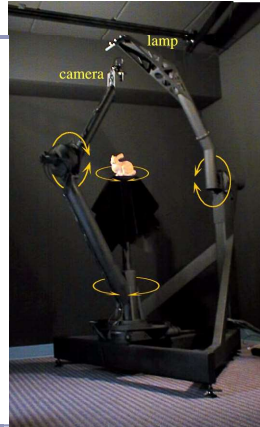

Stanford light gantry 169

Improving on the classic lighting implementations

- Soft shadows are expensive
- Shadows of transparent objects require further coding or hacks
- Lighting off reflective objects follows different shadow rules from normal lighting
- Hard to implement diffuse reflection (color bleeding, such as in the Cornell Box—notice how the sides of the inner cubes are shaded red and green.)
- Fundamentally, the ambient term is a hack and the diffuse term is only one step in what should be a recursive, self-reinforcing series.

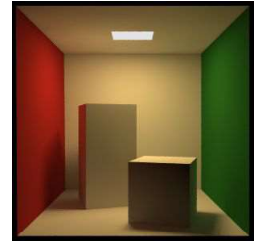

The Cornell Box is a test for rendering Software, developed at Cornell University in 1984 by Don Greenberg. An actual box is built and photographed; an identical scene is then rendered in software and the two images are compared.

170

Ambient occlusion

- *Ambient illumination* is a blanket constant that we often add to every illuminated element in a scene, to (inaccurately) model the way that light scatters off all surfaces, illuminating areas not in direct lighting.
- *Ambient occlusion* is the technique of adding/removing ambient light when other objects are nearby and scattered light wouldn't reach the surface.
- Computing ambient occlusion is a form of *global illumination*, in which we compute the lighting of scene elements in the context of the scene as a whole.

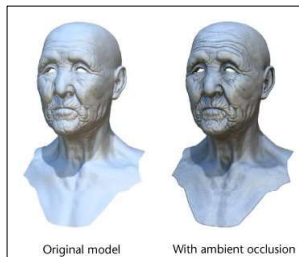

Image from "ZBrush® Character Creation: Advanced Digital Sculpting, Second Edition", by Scott Spencer, 2011 171

Ambient occlusion in action



Car photos from John Hable's presentation at GDC 2010, "Uncharted 2: HDR Lighting" (glimpses.com archive) 172

Ambient occlusion in action



Car photos from John Hable's presentation at GDC 2010, "Uncharted 2: HDR Lighting" (glimpses.com archive) 173

Ambient occlusion in action



Car photos from John Hable's presentation at GDC 2010, "Uncharted 2: HDR Lighting" (glimpses.com archive) 174

Ambient occlusion in action



Car photos from John Hable's presentation at GDC 2010, "Uncharted 2: HDR Lighting" (filmicgames.com/archives/175)

Ambient occlusion - Theory

We can treat the background (the sky) as a vast ambient illumination source.

- For each vertex of a surface, compute how much background illumination reaches the vertex by computing how much sky it can 'see'
- Integrate occlusion A_p over the hemisphere around the normal at the vertex:

$$A_p = \frac{1}{\pi} \int_{\Omega} V_{p,\omega} (\hat{n} \cdot \hat{\omega}) d\omega$$

- A_p occlusion at point p
- \hat{n} normal at point p
- $V_{p,\omega}$ visibility from p in direction ω
- Ω integrate over area (hemisphere)

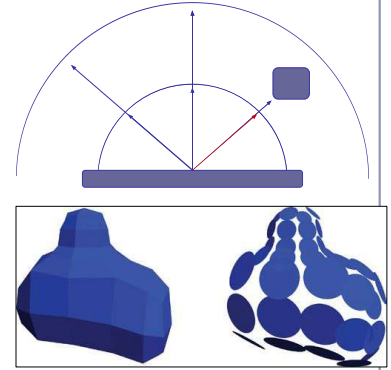

Bottom image credit: "GPU Gems 2", nVidia, 2005. Vertices mapped to illumination disks for hemispheric illumination mapping. 176

Ambient occlusion - Theory

- This approach is very flexible
- Also very expensive!
- To speed up computation, randomly sample rays cast out from each polygon or vertex (this is a Monte-Carlo method)
- Alternatively, render the scene from the point of view of each vertex and count the background pixels in the render
- Best used to pre-compute per-object "occlusion maps", texture maps of shadow to overlay onto each object
- But pre-computed maps fare poorly on animated models...

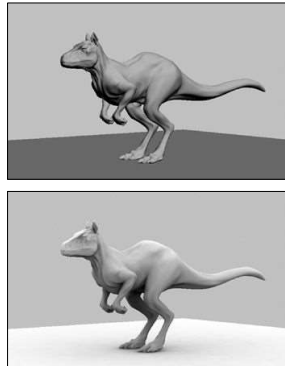

Image credit: "GPU Gems 1", nVidia, 2004. Top: without AO. Bottom: with AO. 177

Screen Space Ambient Occlusion ("SSAO")

"True ambient occlusion is hard, let's go hacking."

- Approximate ambient occlusion by comparing z-buffer values in screen space!
- Open plane = unoccluded
- Closed 'valley' in depth buffer = shadowed by nearby geometry
- Multi-pass algorithm
- Runs entirely on the GPU

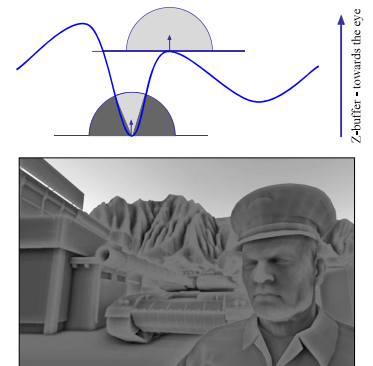

Image: CryEngine 2. M. Mitting, "Finding Next Gen", CryEngine 2.0, Chapter 8, SIGGRAPH 2007 Course 28. 178

Screen Space Ambient Occlusion

1. For each visible point on a surface in the scene (ie., each pixel), take multiple samples (typically between 8 and 32) from nearby and map these samples back to screen space
2. Check if the depth sampled at each neighbor is nearer to, or further from, the scene sample point
3. If the neighbor is nearer than the scene sample point then there is some degree of occlusion
 - a. Care must be taken not to occlude if the nearer neighbor is too much nearer than the scene sample point, this implies a separate object, much closer to the camera
4. Sum retained occlusions, weighting with an occlusion function

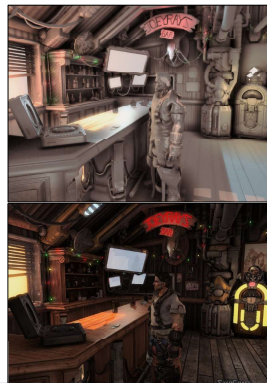
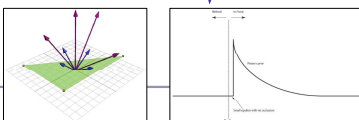

Image: StarCraft II. Advances in Real-Time Rendering in #79, Graphics and Games • Course notes, SIGGRAPH 2008. 179

SSAO example- Uncharted 2



4) Low Pass Filter (significant blurring)

John Hable, GDC 2010, "Uncharted 2: HDR Lighting" (filmicgames.com/archives/6) 180

Ambient occlusion and Signed Distance Fields

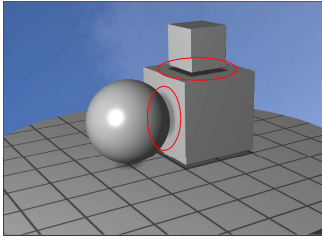

In a nutshell, SSAO tries to estimate occlusion by asking, "how far is it to the nearest neighboring geometry?"
With signed distance fields, this question is almost trivial to answer.

```
float ambient(vec3 pt, vec3 normal) {
    return abs(getSdf(pt + 0.1 * normal)) / 0.1;
}
```

```
float ambient(vec3 pt, vec3 normal) {
    float a = 1;
    int step = 0;
    for (float t = 0.01; t <= 0.1; ) {
        float d = abs(getSdf(pt + t * normal));
        a = min(a, d / t);
        t += max(d, 0.01);
    }
    return a;
}
```

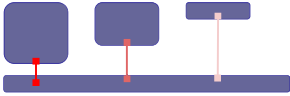

181

Radiosity

- *Radiosity* is an illumination method which simulates the global dispersion and reflection of diffuse light.
 - First developed for describing spectral heat transfer (1950s)
 - Adapted to graphics in the 1980s at Cornell University
- Radiosity is a finite-element approach to global illumination: it breaks the scene into many small elements ('patches') and calculates the energy transfer between them.



Images from Cornell University's graphics group
<http://www.graphics.cornell.edu/online/research/>

182

Radiosity—algorithm

- Surfaces in the scene are divided into *patches*, small subsections of each polygon or object.
- For every pair of patches A, B, compute a *view factor* (also called a *form factor*) describing how much energy from patch A reaches patch B.
 - The further apart two patches are in space or orientation, the less light they shed on each other, giving lower view factors.
- Calculate the lighting of all directly-lit patches.
- Bounce the light from all lit patches to all those they light, carrying more light to patches with higher relative view factors. Repeating this step will distribute the total light across the scene, producing a global diffuse illumination model.

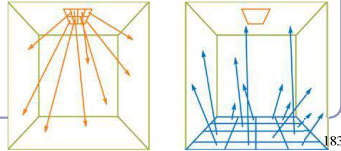

183

Radiosity—mathematical support

The 'radiosity' of a single patch is the amount of energy leaving the patch per discrete time interval.
This energy is the total light being emitted directly from the patch combined with the total light being reflected by the patch:

This forms a system of linear equations, where...

$$B_i = E_i + R_i \sum_{j=1}^n B_j F_{ij}$$

B_i is the radiosity of patch i ;
 B_j is the radiosity of each of the other patches ($j \neq i$)
 E_i is the emitted energy of the patch
 R_i is the reflectivity of the patch
 F_{ij} is the view factor of energy from patch i to patch j .

184

Radiosity—form factors

- Finding form factors can be done procedurally or dynamically
 - Can subdivide every surface into small patches of similar size
 - Can dynamically subdivide wherever the 1st derivative of calculated intensity rises above some threshold.
- Computing cost for a general radiosity solution goes up as the square of the number of patches, so try to keep patches down.
 - Subdividing a large flat white wall could be a waste.
- Patches should ideally closely align with lines of shadow.

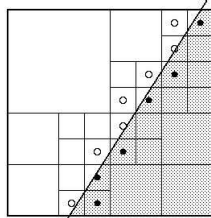

185

Radiosity—implementation

- (A) Simple patch triangulation
 (B) Adaptive patch generation: the floor and walls of the room are dynamically subdivided to produce more patches where shadow detail is higher.

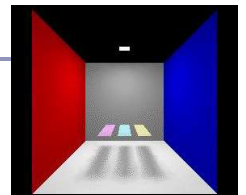

Images from "Automatic generation of node spacing function", IBM (1998)
<http://www.tti.ibm.com/projects/meshing/nsp/nsoE.htm>

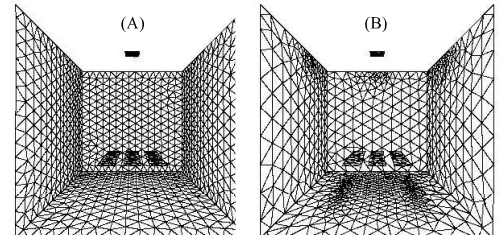

186

Radiosity—view factors

One equation for the view factor between patches i, j is:

$$F_{i \rightarrow j} = \frac{\cos \theta_i \cos \theta_j}{\pi^2 r^2} V(i, j)$$

... where θ is the angle between the normal of patch i and the line to patch j , r is the distance and $V(i, j)$ is the visibility from i to j (0 for occluded, 1 for clear line of sight.)

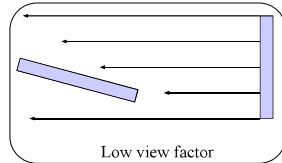
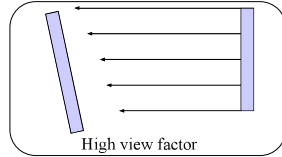
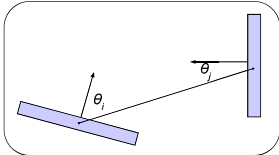

187

Radiosity—calculating visibility

- Calculating $V(i, j)$ can be slow.
- One method is the *hemisphere*, in which each form factor is enclosed in a half-cube. The scene is then 'rendered' from the point of view of the patch, through the walls of the hemisphere; $V(i, j)$ is computed for each patch based on which patches it can see (and at what percentage) in its hemisphere.
- A purer method, but more computationally expensive, uses hemispheres.

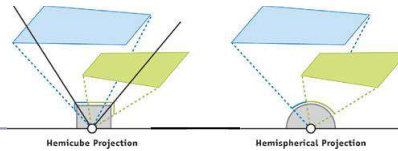

Note: This method can be accelerated using modern graphics hardware to render the scene. The scene is 'rendered' with flat lighting, setting the 'color' of each object to be a pointer to the object in memory.

188

Radiosity gallery

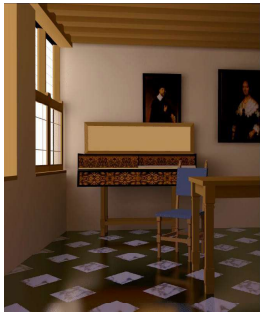

Image from GPU Gems II, nVidia



Teapot (wikipedia)

Image from *A Two Pass Solution to the Rendering Equation: a Synthesis of Ray Tracing and Radiosity Methods*, John R. Wallace, Michael F. Cohen and Donald P. Greenberg (Cornell University, 1987)

189

References

Shirley and Marschner, "Fundamentals of Computer Graphics", Chapter 24 (2009)

Anisotropic surface:

- A. Watt, 3D Computer Graphics - Chapter 7: Simulating light-object interaction: local reflection models
- Eurographics 2016 tutorial - D. Guarnera, G. C. Guarnera, A. Ghosh, C. Denk, and M. Glencross - BRDF Representation and Acquisition

Ambient occlusion and SSAO:

- "GPU Gems 2", nVidia, 2005. Vertices mapped to illumination.
http://http.developer.nvidia.com/GPUGems2/gpugems2_chapter14.html
- Mittring, M. 2007. *Finding Next Gen - CryEngine 2.0*, Chapter 8, SIGGRAPH 2007 Course 28 - Advanced Real-Time Rendering in 3D Graphics and Games
http://developer.amd.com/wordpress/media/2012/10/Chapter8-Mittring-Finding_NextGen_CryEngine2.pdf
- John Hable's presentation at GDC 2010, "Uncharted 2: HDR Lighting" (filmicgames.com/archives/6)

Radiosity:

- http://http.developer.nvidia.com/GPUGems2/gpugems2_chapter39.html
- <http://www.graphics.cornell.edu/online/research/>
- Wallace, J. R., K. A. Elmquist, and E. A. Haines. 1989. "A Ray Tracing Algorithm for Progressive Radiosity." In *Computer Graphics (Proceedings of SIGGRAPH 89)* 23(4), pp. 315-324.
- Buss, "3-D Computer Graphics: A Mathematical Introduction with OpenGL" (Chapter XI), Cambridge University Press (2003)

190

Appendices

Additional topics of interest in computer graphics.
These slides are not examinable.

- Constructive Solid Geometry*
- Perlin Noise*
- NURBS*
- Implicit Surface Modeling*
- Photon Mapping*

Appendix A: Constructive Solid Geometry

Constructive Solid Geometry (CSG) is a ray-tracing technique which builds complicated forms out of simple primitives, comparable to (and more complicated than, but also more precise than) Signed Distance Fields.

These primitives are combined with the standard boolean operations: *union*, *intersection*, *difference*.

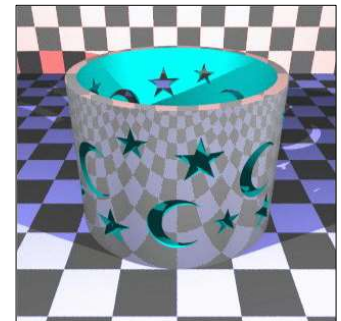

CSG figure by Neil Dodgson

Constructive Solid Geometry

Three operations:

1. Union

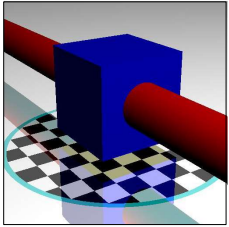

2. Intersection

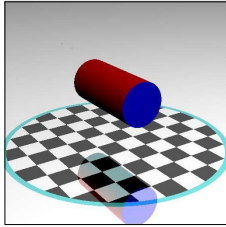

3. Difference

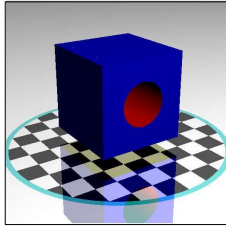

193

Constructive Solid Geometry

CSG surfaces are described by a binary tree, where each leaf node is a primitive and each non-leaf node is a boolean operation.

(What would the *not* of a surface look like?)

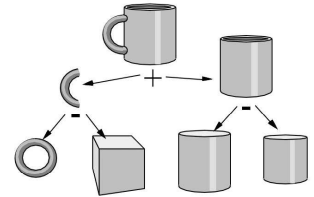

Figure from Wyvill (1995) part two, p. 4

194

Ray-tracing CSG models

For each node of the binary tree:

- Fire ray r at A and B .
- List in t -order all points where r enters or leaves A or B .
 - You can think of each intersection as a quad of booleans--
($wasInA$, $isInA$, $wasInB$, $isInB$)
- Discard from the list all intersections which don't matter to the current boolean operation.
- Pass the list up to the parent node and recurse.

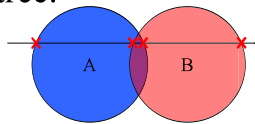

195

Ray-tracing CSG models

Each boolean operation can be modeled as a state machine.

For each operation, retain those intersections that transition into or out of the critical state(s).

- Union: $\{In\ A\ | \ In\ B\ | \ In\ A\ and\ B\}$
- Intersection: $\{In\ A\ and\ B\}$
- Difference: $\{In\ A\}$

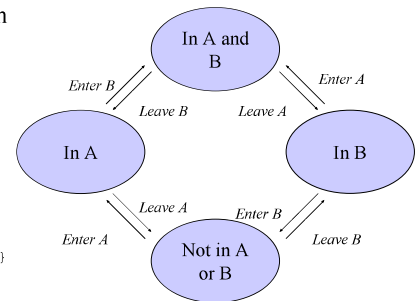

196

Ray-tracing CSG models

Example: Difference (A-B)

A-B	Was In A	Is In A	Was In B	Is In B
t1	No	Yes	No	No
t2	Yes	Yes	No	Yes
t3	Yes	No	Yes	Yes
t4	No	No	Yes	No

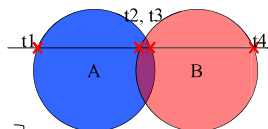

```

difference =
  ((wasInA != isInA) &&
   (!isInB) && (!wasInB))
  ||
  ((wasInB != isInB) &&
   (wasInA || isInA))
    
```

197

Constructive Solid Geometry - References

- Jules Bloomenthal, *Introduction to Implicit Surfaces* (1997)
- Alan Watt, *3D Computer Graphics*, Addison Wesley (2000)
- MIT lecture notes:
<http://groups.csail.mit.edu/graphics/classes/6.837/F98/talecture/>

198

Appendix B: Perlin Noise

By mapping 3D coordinates to colors, we can create *volumetric texture*. The input to the texture is local model coordinates; the output is color and surface characteristics.

For example, to produce wood-grain texture, trees grow rings, with darker wood from earlier in the year and lighter wood from later in the year.

- Choose shades of early and late wood
- $f(P) = (X_p^2 + Z_p^2) \bmod 1$
- $color(P) = earlyWood + f(P) * (lateWood - earlyWood)$



Adding realism

The teapot on the previous slide doesn't look very wooden, because it's perfectly uniform. One way to make the surface look more natural is to add a randomized noise field to $f(P)$:

$$f(P) = (X_p^2 + Z_p^2 + noise(P)) \bmod 1$$

where $noise(P)$ is a function that maps 3D coordinates in space to scalar values chosen at random.

For natural-looking results, use *Perlin noise*, which interpolates smoothly between noise values.



Perlin noise

Perlin noise (invented by Ken Perlin) is a method for generating noise which has some useful traits:

- It is a *band-limited repeatable pseudorandom* function (in the words of its author, Ken Perlin)
- It is bounded within a range close $[-1, 1]$
- It varies continuously, without discontinuity
- It has regions of relative stability
- It can be initialized with random values, extended arbitrarily in space, yet cached deterministically
 - Perlin's talk: <http://www.noisemachine.com/talk1/>

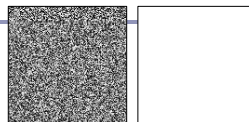

Non-coherent noise (left) and Perlin noise (right)
Image credit: Matt Zucker



Matt Zucker

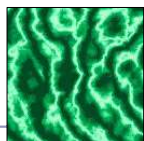

Matt Zucker

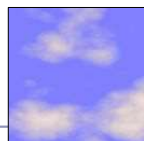

Matt Zucker

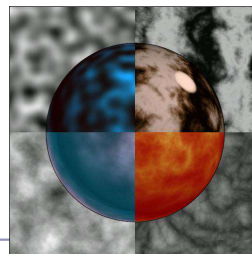

Ken Perlin

201

Perlin noise 1

Perlin noise caches 'seed' random values on a grid at integer intervals. You'll look up noise values at arbitrary points in the plane, and they'll be determined by the four nearest seed randoms on the grid.

Given point (x, y) , let $(s, t) = (\text{floor}(x), \text{floor}(y))$.

For each grid vertex in $\{(s, t), (s+1, t), (s+1, t+1), (s, t+1)\}$ choose and cache a random vector of length one.

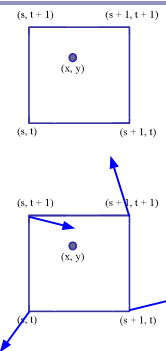

These slides borrow heavily from Mark Zucker's excellent page on Perlin noise at <http://webstaff.itn.iu.se/~stepa/TSM022-2005/perlinnoise/perlinnoise.html> 202

Perlin noise 2

For each of the four corners, take the dot product of the random seed vector with the vector from that corner to (x, y) . This gives you a unique scalar value per corner.

- As (x, y) moves across this cell of the grid, the values of the dot products will change smoothly, with no discontinuity.
- As (x, y) approaches a grid point, the contribution from that point will approach zero.
- The values of LL, LR, UL, UR are clamped to a range close to $[-1, 1]$.

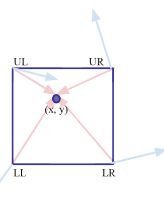
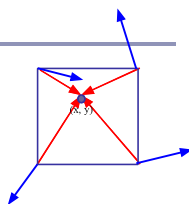

These slides borrow heavily from Mark Zucker's excellent page on Perlin noise at <http://webstaff.itn.iu.se/~stepa/TSM022-2005/perlinnoise/perlinnoise.html> 203

Perlin noise 3

Now we take a weighted average of LL, LR, UL, UR .

Perlin noise uses a weighted averaging function chosen such that values close to zero and one are moved closer to zero and one, called the *ease curve*:

$$S(t) = 3t^2 - 2t^3$$

We interpolate along one axis first:

$$L(x, y) = LL + S(x - \text{floor}(x))(LR - LL)$$

$$U(x, y) = UL + S(x - \text{floor}(x))(UR - UL)$$

Then we interpolate again to merge the two upper and lower functions:

$$noise(x, y) = L(x, y) + S(y - \text{floor}(y))(U(x, y) - L(x, y))$$

Voila!

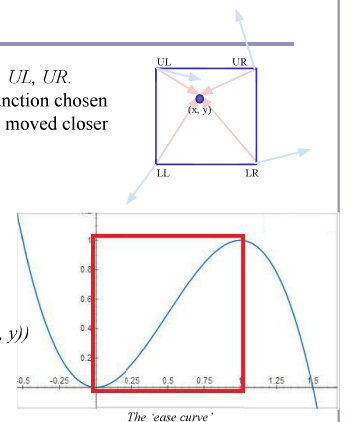

These slides borrow heavily from Mark Zucker's excellent page on Perlin noise at <http://webstaff.itn.iu.se/~stepa/TSM022-2005/perlinnoise/perlinnoise.html> 204

Perlin Noise - References

- <https://web.archive.org/web/20160303232627/http://www.noisemachine.com/talk1/>
- <http://webstaff.itn.liu.se/~stegu/TNM022-2005/perlinnoise/links/perlin-noise-math-faq.html>

205

Appendix C: NURBS

- **NURBS** (“*Non-Uniform Rational B-Splines*”) are a generalization of Beziers.
 - **NU: Non-Uniform.** The knots in the knot vector are not required to be uniformly spaced.
 - **R: Rational.** The spline may be defined by rational polynomials (homogeneous coordinates.)
 - **BS: B-Spline.** A generalized Bezier spline with controllable degree.

B-Splines

We'll build our definition of a B-spline from:

- d , the *degree* of the curve
- $k = d+1$, called the *parameter* of the curve
- $\{P_1 \dots P_n\}$, a list of n *control points*
- $[t_1, \dots, t_{k+n}]$, a *knot vector* of $(k+n)$ parameter values (“knots”)
- $d = k-1$ is the degree of the curve, so k is the number of control points which influence a single interval.
 - Ex: a cubic ($d=3$) has four control points ($k=4$).
- There are $k+n$ knots t_i and $t_i \leq t_{i+1}$ for all t_i
- Each B-spline is $C^{(k-2)}$ continuous: *continuity* is degree minus one, so a $k=3$ curve has $d=2$ and is $C1$.

B-Splines

- The equation for a B-spline curve is

$$P(t) = \sum_{i=1}^n N_{i,k}(t)P_i, \quad t_{min} \leq t < t_{max}$$

- $N_{i,k}(t)$ is the *basis function* of control point P_i for parameter k . $N_{i,k}(t)$ is defined recursively:

$$N_{i,1}(t) = \begin{cases} 1, & t_i \leq t < t_{i+1} \\ 0, & \text{otherwise} \end{cases}$$

$$N_{i,k}(t) = \frac{t - t_i}{t_{i+k-1} - t_i} N_{i,k-1}(t) + \frac{t_{i+k} - t}{t_{i+k} - t_{i+1}} N_{i+1,k-1}(t)$$

B-Splines

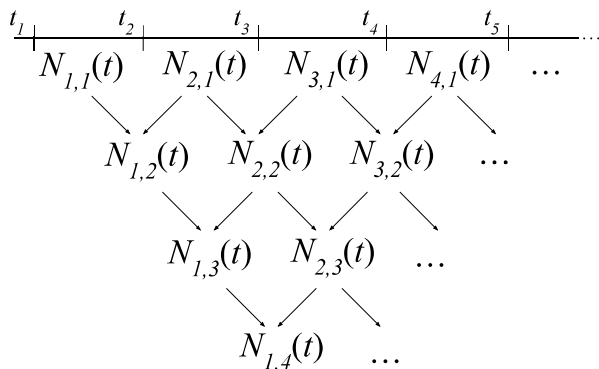

B-Splines

$$N_{i,1}(t) = \begin{cases} 1, & t_i \leq t < t_{i+1} \\ 0, & \text{otherwise} \end{cases}$$

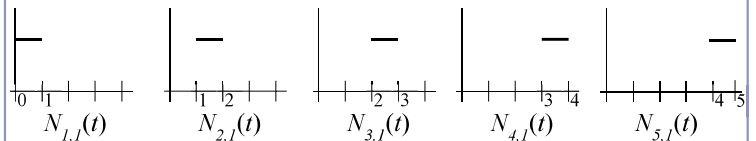

$t_1 = 0.0$
 $t_2 = 1.0$
 $t_3 = 2.0$
 $t_4 = 3.0$
 $t_5 = 4.0$
 $t_6 = 5.0$

$$N_{1,l}(t)=1, 0 \leq l < 1$$

$$N_{3,l}(t)=1, 2 \leq l < 3$$

$$N_{5,l}(t)=1, 4 \leq l < 5$$

$$N_{2,l}(t)=1, 1 \leq l < 2$$

$$N_{4,l}(t)=1, 3 \leq l < 4$$

Knot vector = $\{0,1,2,3,4,5\}$, $k = 1 \rightarrow d = 0$ (degree = zero)

B-Splines

$$N_{i,k}(t) = \frac{t - t_i}{t_{i+k-1} - t_i} N_{i,k-1}(t) + \frac{t_{i+k} - t}{t_{i+k} - t_{i+1}} N_{i+1,k-1}(t)$$

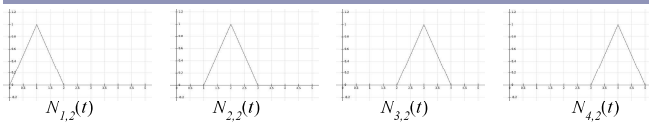

$$N_{1,2}(t) = \frac{t-0}{1-0}N_{1,1}(t) + \frac{2-t}{2-1}N_{2,1}(t) = \begin{cases} t & 0 \leq t < 1 \\ 2-t & 1 \leq t < 2 \end{cases}$$

$$N_{2,2}(t) = \frac{t-1}{2-1}N_{2,1}(t) + \frac{3-t}{3-2}N_{3,1}(t) = \begin{cases} t-1 & 1 \leq t < 2 \\ 3-t & 2 \leq t < 3 \end{cases}$$

$$N_{3,2}(t) = \frac{t-2}{3-2}N_{3,1}(t) + \frac{4-t}{4-3}N_{4,1}(t) = \begin{cases} t-2 & 2 \leq t < 3 \\ 4-t & 3 \leq t < 4 \end{cases}$$

$$N_{4,2}(t) = \frac{t-3}{4-3}N_{4,1}(t) + \frac{5-t}{5-4}N_{5,1}(t) = \begin{cases} t-3 & 3 \leq t < 4 \\ 5-t & 4 \leq t < 5 \end{cases}$$

Knot vector = $\{0,1,2,3,4,5\}$, $k=2 \rightarrow d=1$ (degree = one)

B-Splines

$$N_{i,k}(t) = \frac{t - t_i}{t_{i+k-1} - t_i} N_{i,k-1}(t) + \frac{t_{i+k} - t}{t_{i+k} - t_{i+1}} N_{i+1,k-1}(t)$$

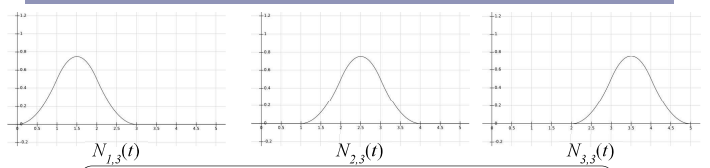

$$N_{1,3}(t) = \frac{t-0}{2-0}N_{1,2}(t) + \frac{3-t}{3-1}N_{2,2}(t) = \begin{cases} t^2/2 & 0 \leq t < 1 \\ -t^2 + 3t - 3/2 & 1 \leq t < 2 \\ (3-t)^2/2 & 2 \leq t < 3 \end{cases}$$

$$N_{2,3}(t) = \frac{t-1}{3-1}N_{2,2}(t) + \frac{4-t}{4-2}N_{3,2}(t) = \begin{cases} (t-1)^2/2 & 1 \leq t < 2 \\ -t^2 + 5t - 11/2 & 2 \leq t < 3 \\ (4-t)^2/2 & 3 \leq t < 4 \end{cases}$$

$$N_{3,3}(t) = \frac{t-2}{4-2}N_{3,2}(t) + \frac{5-t}{5-3}N_{4,2}(t) = \begin{cases} (t-2)^2/2 & 2 \leq t < 3 \\ -t^2 + 7t - 23/2 & 3 \leq t < 4 \\ (5-t)^2/2 & 4 \leq t < 5 \end{cases}$$

Knot vector = $\{0,1,2,3,4,5\}$, $k=3 \rightarrow d=2$ (degree = two)

Basis functions really sum to one (k=2)

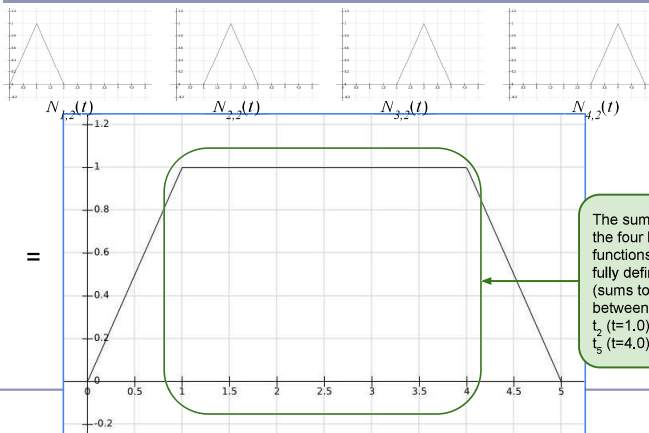

Basis functions really sum to one (k=3)

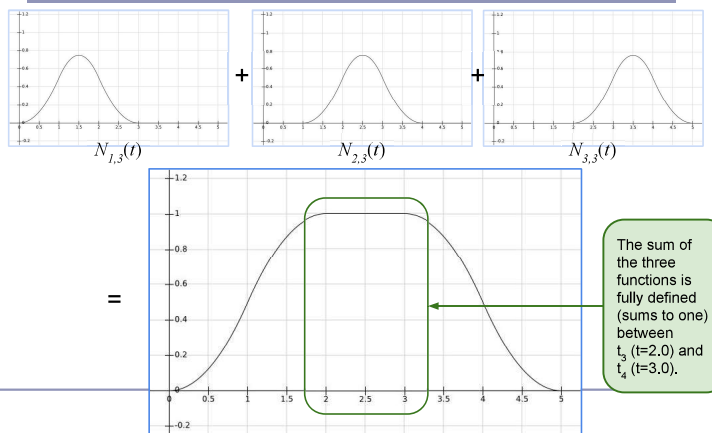

B-Splines

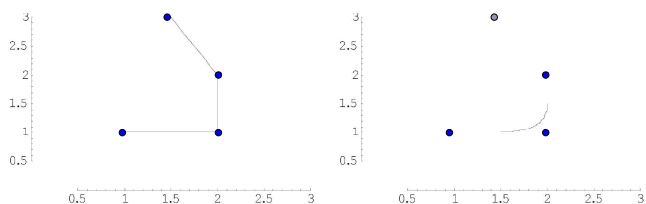

At $k=2$ the function is piecewise linear, depends on P_1, P_2, P_3, P_4 , and is fully defined on $[t_2, t_3]$.

At $k=3$ the function is piecewise quadratic, depends on P_1, P_2, P_3 , and is fully defined on $[t_3, t_4]$.

Each parameter- k basis function depends on $k+1$ knot values; $N_{i,k}$ depends on t_i through t_{i+k} , inclusive. So six knots \rightarrow five discontinuous functions \rightarrow four piecewise linear interpolations \rightarrow three quadratics, interpolating three control points. $n=3$ control points, $d=2$ degree, $k=3$ parameter, $n+k=6$ knots.

Knot vector = $\{0,1,2,3,4,5\}$

Non-Uniform B-Splines

- The knot vector $\{0,1,2,3,4,5\}$ is *uniform*:

$$t_{i+1} - t_i = t_{i+2} - t_{i+1} \quad \forall t_i$$
- Varying the size of an interval changes the parametric-space distribution of the weights assigned to the control functions.
- Repeating a knot value reduces the continuity of the curve in the affected span by one degree.
- Repeating a knot k times will lead to a control function being influenced only by that knot value; the spline will pass through the corresponding control point with $C0$ continuity.

Open vs Closed

- A knot vector which repeats its first and last knot values k times is called *open*, otherwise *closed*.
- Repeating the knots k times is the only way to force the curve to pass through the first or last control point.
- Without this, the functions $N_{j,k}$ and $N_{n,k}$ which weight P_j and P_n would still be ‘ramping up’ and not yet equal to one at the first and last t_i .

Open vs Closed

- Two examples you may recognize:
 - $k=3, n=3$ control points, knots= $\{0,0,0,1,1,1\}$
 - $k=4, n=4$ control points, knots= $\{0,0,0,0,1,1,1,1\}$

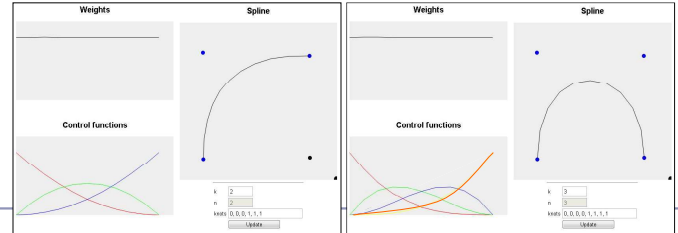

Non-Uniform Rational B-Splines

- Repeating knot values is a clumsy way to control the curve’s proximity to the control point.
 - The solution: *homogeneous coordinates*.
 - Associate a ‘weight’ with each control point, ω_p , so that the expression becomes a weighted average
 - This allows us to slide the curve nearer or farther to individual control points without losing continuity or introducing new control points.

Non-Uniform Rational B-Splines in action

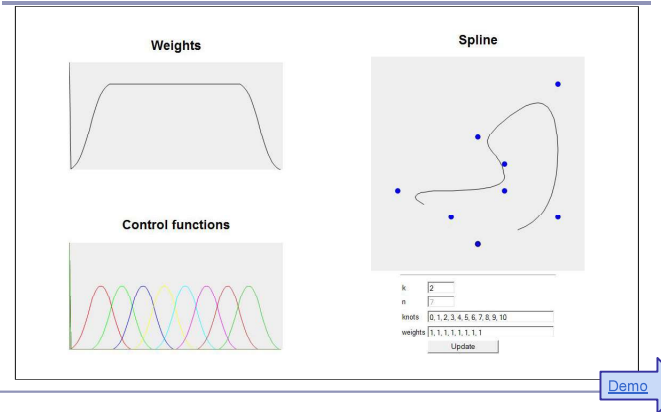

NURBS - References

- Les Piegl and Wayne Tiller, *The NURBS Book*, Springer (1997)
- Alan Watt, *3D Computer Graphics*, Addison Wesley (2000)
- G. Farin, J. Hoschek, M.-S. Kim, *Handbook of Computer Aided Geometric Design*, North-Holland (2002)

Appendix D: Implicit surface modeling

Implicit surface modeling⁽¹⁾ is a way to produce very ‘organic’ or ‘bulbous’ surfaces very quickly without subdivision or NURBS.

Uses of implicit surface modelling:

- Organic forms and nonlinear shapes
- Scientific modeling (electron orbitals, gravity shells in space, some medical imaging)
- Muscles and joints with skin
- Rapid prototyping
- CAD/CAM solid geometry

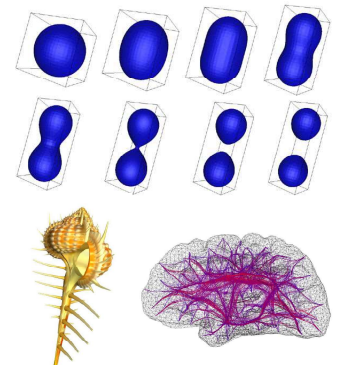

⁽¹⁾ AKA “metaball modeling”, “force functions”, “blobby modeling”...

How it works

The user controls a set of *control points*; each point in space generates a field of force, which drops off as a function of distance from the point. This 3D field of forces defines an *implicit surface*: the set of all the points in space where the force field sums to a key value.

A few popular force field functions:

- “Blobby Molecules” – Jim Blinn

$$F(r) = a e^{-br^2}$$
- “Metaballs” – Jim Blinn

$$F(r) = \begin{cases} a(1 - 3r^2 / b^2) & 0 \leq r < b/3 \\ (3a/2)(1-r/b)^2 & b/3 \leq r < b \\ 0 & b \leq r \end{cases}$$
- “Soft Objects” – Wyvill & Wyvill

$$F(r) = a(1 - 4r^6/9b^6 + 17r^4/9b^4 - 22r^2/9b^2)$$

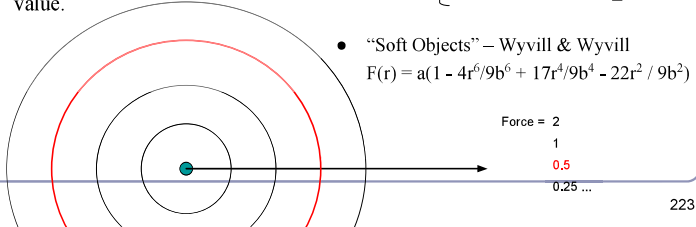

223

Discovering the surface

An *octree* is a recursive subdivision of space which “homes in” on the surface, from larger to finer detail.

- An octree encloses a cubical volume in space. You evaluate the force function $F(v)$ at each vertex v of the cube.
- As the octree subdivides and splits into smaller octrees, only the octrees which contain some of the surface are processed; empty octrees are discarded.

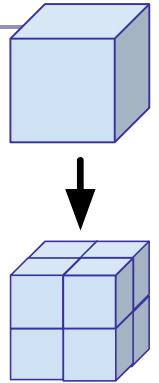

224

Polygonizing the surface

To display a set of octrees, convert the octrees into polygons.

- If some corners are “hot” (above the force limit) and others are “cold” (below the force limit) then the implicit surface crosses the cube edges in between.
- The set of midpoints of adjacent crossed edges forms one or more rings, which can be triangulated. The normal is known from the hot/cold direction on the edges.

To refine the polygonization, subdivide recursively; discard any child whose vertices are all hot or all cold.

225

Polygonizing the surface

Recursive subdivision (on a quadtree):

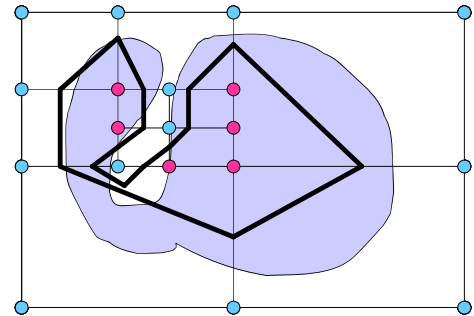

226

Polygonizing the surface

There are fifteen possible configurations (up to symmetry) of hot/cold vertices in the cube. →
 • With rotations, that's 256 cases.

Beware: there are *ambiguous cases* in the polygonization which must be addressed separately. ↓

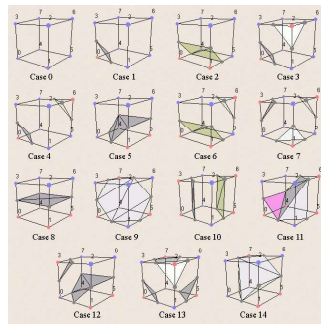
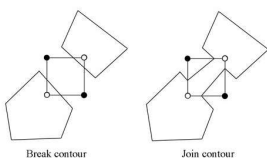

Images courtesy of [Diane Lingrand](#)

227

Smoothing the surface

Improved edge vertices

- The naïve implementation builds polygons whose vertices are the midpoints of the edges which lie between hot and cold vertices.
- The vertices of the implicit surface can be more closely approximated by points linearly interpolated along the edges of the cube by the weights of the relative values of the force function.
 - $t = (0.5 - F(P1)) / (F(P2) - F(P1))$
 - $P = P1 + t(P2 - P1)$

228

Bloppy Modeling - References

- D. Ricci, A Constructive Geometry for Computer Graphics, Computer Journal, May 1973
 J Bloomenthal, Polygonization of Implicit Surfaces, Computer Aided Geometric Design, Issue 5, 1988
 B Wyvill, C McPheeters, G Wyvill, Soft Objects, Advanced Computer Graphics (Proc. CG Tokyo 1986)
 B Wyvill, C McPheeters, G Wyvill, Animating Soft Objects, The Visual Computer, Issue 4 1986
<http://astronomy.swin.edu.au/~pbourke/modelling/impliciturf/>
<http://www.cs.berkeley.edu/~job/Papers/turk-2002-MIS.pdf>
<http://www.unchainedgeometry.com/jbloom/papers/interactive.pdf>
<http://www-courses.cs.uiuc.edu/~cs319/polygonization.pdf>

229

Appendix E: Photon Mapping

- Problem: shadow ray strikes transparent, refractive object.
 - Refracted shadow ray will now miss the light.
 - This destroys the validity of the boolean shadow test.
- Problem: light passing through a refractive object will sometimes form *caustics* (right), artifacts where the envelope of a collection of rays falling on the surface is bright enough to be visible.



This is a photo of a real pepper-shaker. Note the caustics to the left of the shaker, in and outside of its shadow.
 Photo credit: Jan Zankowski

230

Shadows, refraction and caustics

- Solutions for shadows of transparent objects:
 - Backwards ray tracing (Arvo)
 - *Very* computationally heavy
 - Improved by stencil mapping (Shenya et al)
 - Shadow attenuation (Pierce)
 - Low refraction, no caustics
- More general solution:
 - *Photon mapping* (Jensen)→

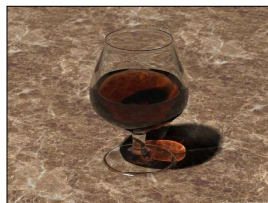

Image from <http://graphics.mcgill.edu/~henrik/>
 Generated with photon mapping

231

Photon mapping

Photon mapping is the process of emitting photons into a scene and tracing their paths probabilistically to build a *photon map*, a data structure which describes the illumination of the scene independently of its geometry.

This data is then combined with ray tracing to compute the global illumination of the scene.

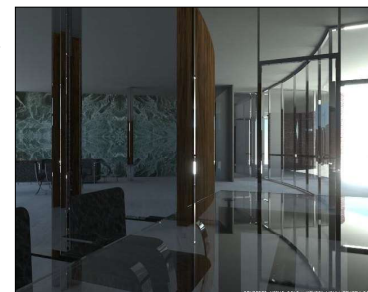

Image by Henrik Jensen (2000)

232

Photon mapping—algorithm (1/2)

Photon mapping is a two-pass algorithm:

1. Photon scattering
 - A. Photons are fired from each light source, scattered in randomly-chosen directions. The number of photons per light is a function of its surface area and brightness.
 - B. Photons fire through the scene (re-use that raytracer, folks.) Where they strike a surface they are either absorbed, reflected or refracted.
 - C. Wherever energy is absorbed, cache the location, direction and energy of the photon in the *photon map*. The photon map data structure must support fast insertion and fast nearest-neighbor lookup; a *kd-tree* is often used.

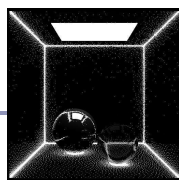

Image by Zack Waters

233

Photon mapping—algorithm (2/2)

Photon mapping is a two-pass algorithm:

2. Rendering
 - A. Ray trace the scene from the point of view of the camera.
 - B. For each first contact point P use the ray tracer for specular but compute diffuse from the photon map and do away with ambient completely.
 - C. Compute radiant illumination by summing the contribution along the eye ray of all photons within a sphere of radius r of P .
 - D. Caustics can be calculated directly here from the photon map. For speed, the caustic map is usually distinct from the radiance map.

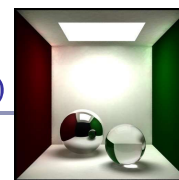

Image by Zack Waters

234

Photon mapping is probabilistic

This method is a great example of *Monte Carlo integration*, in which a difficult integral (the lighting equation) is simulated by randomly sampling values from within the integral's domain until enough samples average out to about the right answer.

- This means that you're going to be firing *millions* of photons. Your data structure is going to have to be very space-efficient.

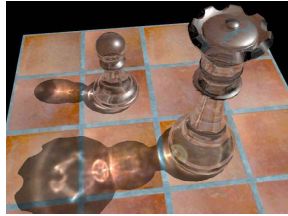

Image credit: http://www.okino.com/conv_rmp_jt.htm 235

Photon mapping is probabilistic

- Initial photon direction is random. Constrained by light shape, but random.
- What exactly happens each time a photon hits a solid also has a random component:
 - Based on the diffuse reflectance, specular reflectance and transparency of the surface, compute probabilities p_d , p_s and p_t where $(p_d + p_s + p_t) \leq 1$. This gives a probability map:

0 p_d p_s p_t 1 *This surface would have minimal light.*

• Choose a random value $p \in [0, 1]$. Where p falls on the probability map of the surface determines whether the photon is reflected, refracted or absorbed.

236

Photon mapping gallery

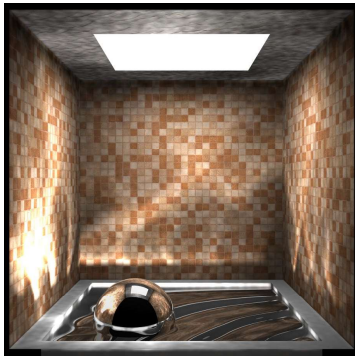

http://web.cs.wpi.edu/~emmanuel/courses/cs563/write_ups/zackw/photon_mapping/PhotonMapping.html



<http://graphics.ucsd.edu/~henrik/images/global.html>



<http://www.pbrt.org/gallery.php>

237

Photon Mapping - References

- Henrik Jensen, "Global Illumination using Photon Maps": <http://graphics.ucsd.edu/~henrik/>
- Henrik Jensen, "Realistic Image Synthesis Using Photon Mapping"
- Zack Waters, "Photon Mapping": http://web.cs.wpi.edu/~emmanuel/courses/cs563/write_ups/zackw/photon_mapping/PhotonMapping.html

238